

## Sistemi di installazione

### ATTENZIONE:

LA SICUREZZA DELL'APPARECCHIO E' GARANTITA SOLO CON L'USO APPROPRIATO DELLE SEGUENTI ISTRUZIONI; PERTANTO E' NECESSARIO CONSERVARLE.

### WARNING:

THE SAFETY OF THIS FIXTURE IS GUARANTEED ONLY IF YOU COMPLY WITH THESE INSTRUCTIONS; REMEMBER TO CONSERVE IN A SAFE PLACE.

### ATTENTION:

LA SECUTIE DE L'APPAREIL N'EST GARANTIE QU'EN CAS D'UTILISATION CORRECTE DES INSTRUCTIONS SUIVANTES; IL FAUT PAR CONSEQUENT LES CONSERVER.

### ACHTUNG:

DIE SICHERHEIT DES GERÄTES WIRD NUR DURCH SACHGEMÄSSE BEFOLGUNG NACHSTEHENDER ANWEISUNGEN GEWÄHRLEISTET; IHRE AUFBEWAHRUNG IST DESHALB SEHR WICHTIG.

### ATTENTIE:

DE VEILIGHEID VAN DE APPARATUUR IS SLECHTS DAN GEGARANDEERD ALS MEN DE VOLGENDE INSTRUKTIES STRIKT OPVOLGT; DAAROM MOET MEN ZE OOK BEWAREN.

### ATENCION:

LA SEGURIDAD DEL APARATO SE GARANTIZA SOLO CUMPLIENDO CUIDADOSAMENTE LAS SIGUIENTES INSTRUCCIONES; POR ELLO, ES NECESARIO CONSERVARLAS.

### BEMÆRK:

SIKKERHEDEN VED BRUG AF ARMATURET KAN KUN GARANTERES, HVIS DISSE ANVISNINGER FØLGES; SØRG DERFOR FOR AT GEMME DEM.

### ADVARSEL:

SIKKERHETENTIL DETTE APPARATET GARANTERES KUN HVIS DU OVERHOLDER DISSE INSTRUKSJONENE; HUSK Å OPPBEVARE DEM PÅ ET TRYGT STED.

### OBSERVERA!

UTRUSTNINGENS SÄKERHET KAN ENDAST GARANTERAS OM DESSA ANVISNINGAR RESPEKTERAS I DETALJ. SPARA DÄRFÖR DESSA ANVISNINGAR FÖR FRAMTIDA KONSULTATION.

### ВНИМАНИЕ:

МЫ ГАРАНТИРУЕМ БЕЗОПАСНУЮ ЭКСПЛУАТАЦИЮ ИЗДЕЛИЯ ТОЛЬКО ПРИ СОБЛЮДЕНИИ СЛЕДУЮЩИХ ИНСТРУКЦИЙ; С ЭТОЙ ЦЕЛЬЮ НЕОБХОДИМО СОХРАНИТЬ ДАННУЮ БРОШЮРУ.

### 警告:

为确保该装置安全，请遵守操作指示；并于安全场所放置。

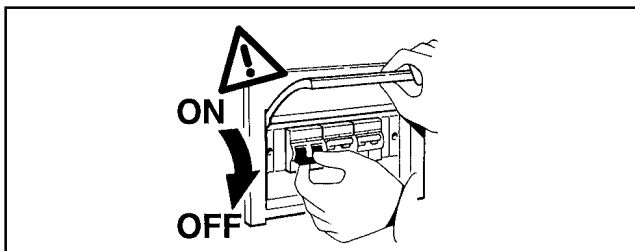

N.B.: DURANTE L'INSTALLAZIONE DEL SISTEMA RISPETTARE SCRUPOLOSAMENTE LE NORME IMPIANTISTICHE NAZIONALI VIGENTI.

N.B.: WHEN INSTALLING THE SYSTEM, MAKE SURE ALL CURRENT NATIONAL REGULATIONS RELATING TO INSTALLATION ARE OBSERVED.

N.B.: LORS DE L'INSTALLATION DU SYSTÈME VEUILLEZ RESPECTER RIGOREUSEMENT LES NORMES EN VIGUEUR EN LA MATIÈRE DANS LE PAYS.

N.B.: BEACHTEN SIE BEI DER INSTALLATION DES SYSTEMS UNBEDINGT DIE IM LAND GELTENDEN ANLAGETECHNISCHEN VORSCHRIFTEN.

N.B.: BIJ HET INSTALLEREN VAN HET SYSTEEM MOET U DE GELDENDE NATIONALE INSTALLATIENORMEN STRIKT NALEVEN.

NOTA: DURANTE LA INSTALACIÓN DEL SISTEMA RESPETAR ESCRUPULOSAMENTE LAS NORMAS NACIONALES DE INSTALACION EN VIGOR.

N.B.: UNDER INSTALLATION AF SYSTEMET SKAL MAN NØJE OVERHOLDE DE GÆLDENDE REGLER FOR DISSE ANLÆG.

N.B.: UNDER INSTALLASJON AV SYSTEMET MÁ DE NASJONALE ANLEGGSFORSKRIFTENE OVERHOLDES NØYE.

OBS! UNDER INSTALLATIONEN AV SYSTEMET SKA GÄLLANDE NATIONELLA INSTALLATIONSFORESKRIFTER RESPEKTERAS I DETALJ.

ПРИМЕЧАНИЕ: В ПРОЦЕССЕ МОНТАЖА СИСТЕМЫ СТРОГО СОБЛЮДАЙТЕ НАЦИОНАЛЬНЫЕ ДЕЙСТВУЮЩИЕ НОРМАТИВЫ ПО ЭЛЕКТРОПРОВОДКЕ.

注意：在安装系统时请遵守设备的安装规定。

## WOW

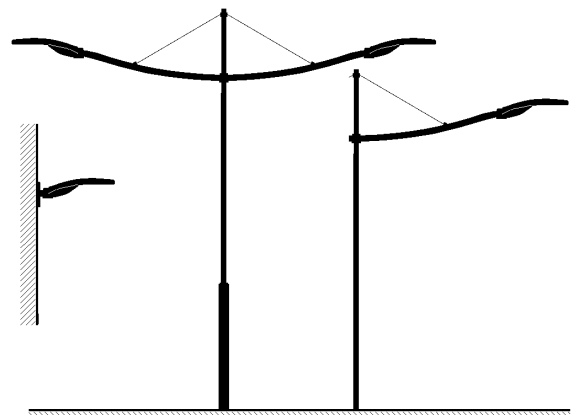
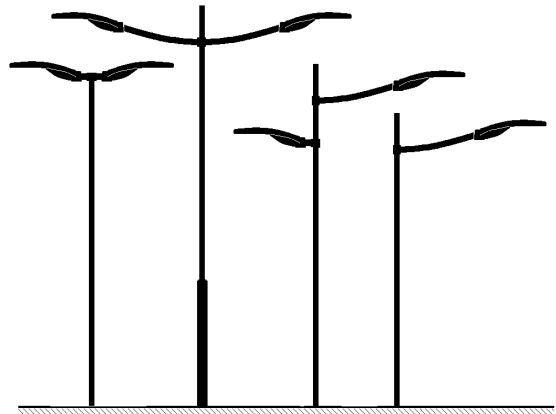

## STREET

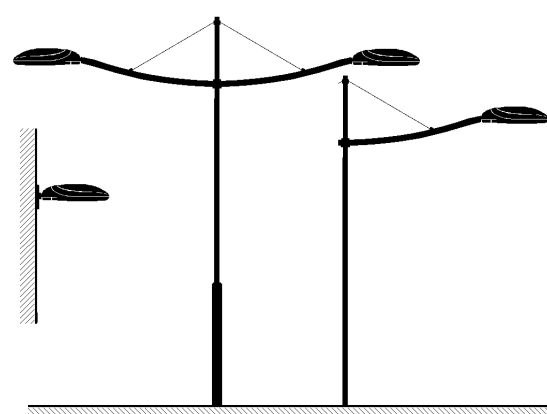
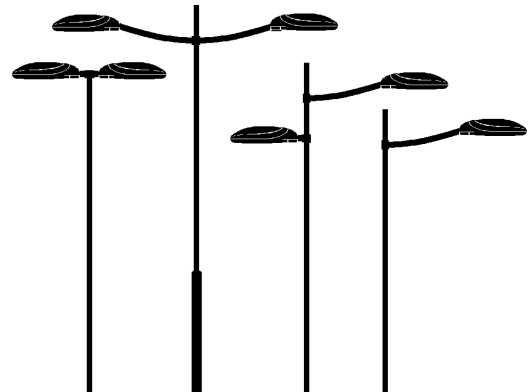

# ARCHILEDE

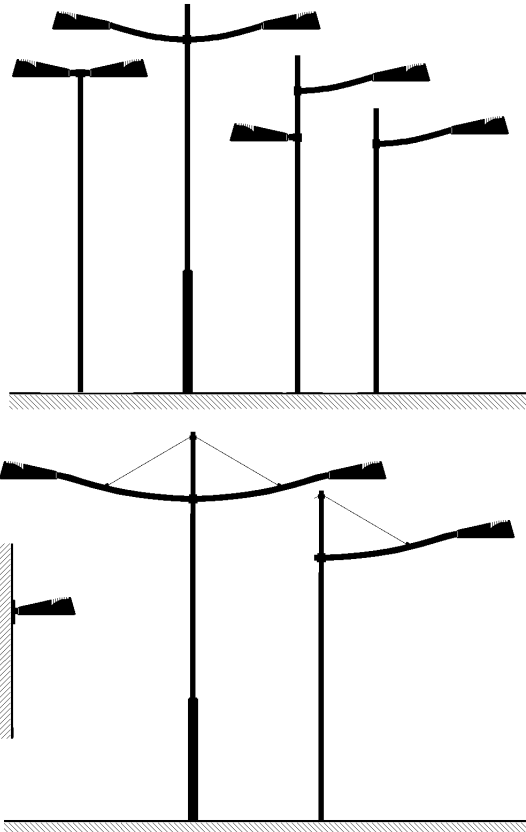

INSTALLAZIONE AD APPLIQUE CON L' ART. 6160  
 WALL APPLICATION WITH ART. 6160  
 INSTALLATION EN APPLIQUE AVEC L' ART. 6160  
 WANDINSTALLATION MIT DEM ART. 6160  
 INSTALLATIE ALS WANDARMATUUR MET ART. 6160  
 INSTALACIÓN EN PARED CON ART. 6160  
 VÆGMONTERING MED ART. 6160  
 VEGGAPPLIKASJON MED ART. 6160  
 LAMPETTINSTALLATION MED ART. 6160  
**МОНТАЖ БРА С ИЗДЕЛИЕМ** ART. 6160 壁式

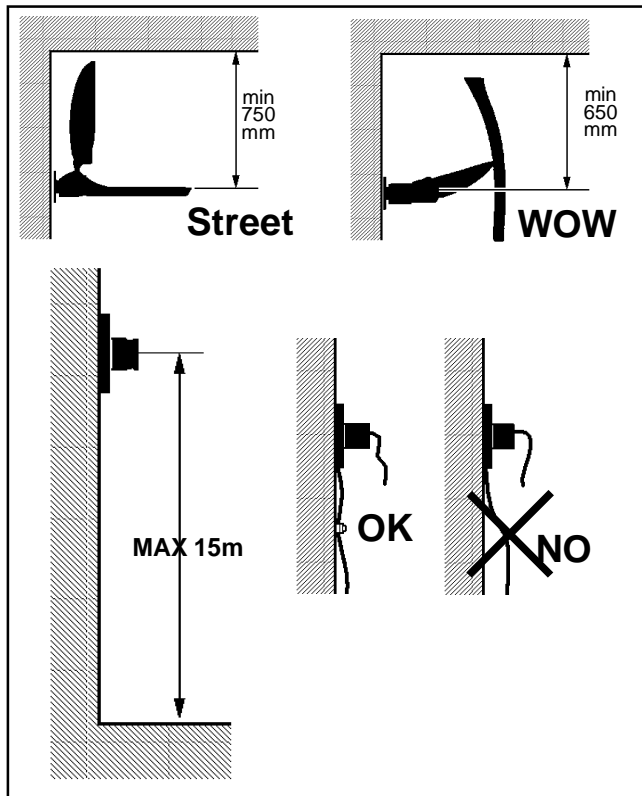

I Evitare che il peso del cavo o sue trazioni accidentali gravino sul prodotto.  
**N.B.:** \*Non sottoporre a trazioni superiori agli 80 N.  
**GB** The cable weighing on the product or being accidentally tugged may cause damage to the product. Avoid both.  
**N.B.:** \*Do not subject to tugs greater than 80 N.  
**F** Evitez que le poids du câble ou ses tractions accidentelles grèvent sur le produit.  
**N.B.:** \*Ne pas soumettre à des tractions dépassant 80 N.  
**D** Achten Sie darauf, dass das Gewicht des Kabels oder eventuell auf dieses einwirkende, plötzliche Zugkräfte die Leuchte nicht belasten.  
**N.B.:** \*Vermeiden Sie eine Zugkraft von über 80 N.  
**NL** Vermijd dat het gewicht van de kabels of accidentele tracties het product belasten.  
**N.B.:** \*Onderwerp ze niet aan een tractie die hoger is dan 80 N.  
**E** Evitar cargar el peso del cable o sus tracciones accidentales sobre el producto.  
**NOTA:** \*No someter a tracciones superiores a 80 N.  
**DK** Undgå, at produktet belastes af vægten fra ledningen eller utilsigtede trækpåvirkninger.  
**N.B.:** \*Forbindelsen må ikke udsættes for trækpåvirkninger på over 80 N.  
**N** Kabelvægt på produktet eller ved å bli utilsikket strukket kan forårsake skade på produktet. Unngå begge.  
**N.B.:** \*Ikke utsett for drakrefter som er større enn 80 N.  
**S** Undvik att kabelns vikt eller dess dragspänning sliter på utrustningen.  
**OBS!** \*Utsätt dem inte för dragkrafter över 80 N.  
**RUS** Избегайте, чтобы вес кабеля или его случайного натяжение оказывали нагрузку на прибор.  
**ПРИМЕЧАНИЕ:** \*Не подвергать натяжению с усилием более 80 Н.  
**CN** 电缆压在产品上或偶然拖拉可能会导致产品损坏。皆应避免。  
 注意: \*请勿使其受大于80N的拖曳力。

PER IL FISSAGGIO USARE TASSELLI AD ESPANSIONE CON VITI M8; IL TIPO DI TASSELLO DA USARE (NYLON, ACCIAIO, A REAZIONE CHIMICA ...) E' DA SCEGLIERE IN FUNZIONE DELLE CARATTERISTICHE DEL MATERIALE DI SUPPORTO (MURATURA, CALCESTRUZZO, METALLO ...) SU CUI VIENE APPLICATO IL PRODOTTO.  
**FOR ATTACHMENT, USE EXPANSION PLUGS WITH M8 SCREW; CHOOSE THE TYPE OF PLUG ( NYLON, STEEL, CHEMICAL REACTION ...) ACCORDING TO THE CHARACTERISTICS OF THE SURFACE ( MASONRY, CONCRETE, METAL ...) TO WHICH IT IS APPLIED.**  
**POUR LA FIXATION, UTILISEZ DES CHEVILLES A EXPANSION ET DES VIS M8, LE TYPE DE CHEVILLE DEVANT ÊTRE UTILISÉ (NYLON, ACIER, A REACTION CHIMIQUE ...) DOIT ÊTRE CHOISI EN FONCTION DES CARACTERISTIQUES DU MATERIAU DE SUPPORT (MACHONNERIE, BETON, METAL ...) DU PRODUIT.**  
**FÜR DIE BEFESTIGUNG SPREIZDÜBEL MIT SCHRAUBE M8 VERWENDEN; DER ZU VERWENDEDE DÜBELTYP ( AUS NYLON, STAHL, MIT CHEMISCHER REAKTION ...) HÄNGT VON DEN EIGENSCHAFTEN DES BEFESTIGUNGSMATERIALS ( MAUERWERK, BETON, METALL ...) AN DEM DAS PRODUKT MONTIERT WIRD, AB.**  
**VOOR HET BEVESTIGEN GEBRUIKT MEN EXPANSIEPLUGGEN MET SCHROEVEN M 8; HET TE GEBRUIKEN TYPE PLUG (NYLON, STAAL, CHEMISH REAGEREND ...) HANGT AF VAN DE KENMERKEN VAN HET MATERIAAL WAAROP HET PRODUKT WORDT AANGEBRACHT ( METSELWERK, BETON, METAL ... ).**  
**PARA LA FIJACION UTILIZAR TARUGOS DE EXPANSION CON TORNILLOS M8; EL TIPO DE TARUGO QUE DEBE USARSE ( NYLON, ACERO, DE REACCION QUIMICA ...) DEBERA ELEGIRSE EN FUNCION DE LAS CARACTERISTICAS DEL MATERIAL DE SOPORTE ( MAMPOSTERIA, HORMIGON, METAL ...) EN EL CUAL DEBE APLICARSE EL PRODUCTO.**  
**FOR FASTGØRELSE SKAL MAN ANVENDE RAWLPLUGS MED SKRUE R Ø 10. DE PLUGS, DER KAN ANVENDES (NYLON, STÅL, MED KEMISK REAKTION ...) SKAL VÆLGES UD FRA MONTERINGSFLADERNES EGENSKABER (MURVÆRK, BETON, METAL ...) HVOR PRODUKTET SKAL MONTERES.**  
**FOR FESTE, BRUK EKSPANSJONSPLUGGER MED Ø 10 SKRUE, VELG TYPE PLUGG (NYLON, STÅL, KJEMISK REAKSJON...) ETTER EGENSKAPENE PÅ OVERFLATEN (MUR, BETONG, METALL...) SOM DE ER PÅFØRT.**  
**FÖR FASTSÄTTNINGEN SKA EXPANSJONSPLUGGAR MED Ø 10 SKRUV ANVÄNDAS. TYPER AV PLUGG (NYLON, STÅL, KEMISK REAKTION O.S.V.) SKA VÄLJAS BERÖENDE PÅ DET BÄRANDE MATERIALETS EGENSKAPER (MURVERK, BETONG, METALL O.S.V.) DÄR PRODUKTEN APPLICERAS.**  
**ДЛЯ КРЕПЛЕНИЯ ИСПОЛЬЗУЙТЕ РАСШИРИТЕЛЬНЫЕ ВКЛАДЫШ С ШРУПАМИ М8; ТИП ИСПОЛЬЗУЙТЕГО ВКЛАДЫША (НЕЙЛОН, СТАЛЬ, С ХИМИЧЕСКОЙ РЕАКЦИЕЙ...) ВЫБИРАЕТСЯ ПО ХАРАКТЕРИСТИКАМ МАТЕРИАЛА ОСНОВАНИЯ, К КОТОРОМУ КРЕПИТСЯ СИСТЕМА (КЛАДКА, БЕТОН, МЕТАЛЛ...). К КОТОРОМУ КРЕПИТСЯ ПРИБОР.**  
**至于附加装置，使用带M8螺丝的膨胀塞；根据使用塞子的表面（砖石、混凝土、金属……）的特征选择塞子的类型（尼龙、钢、化学处理……）。**

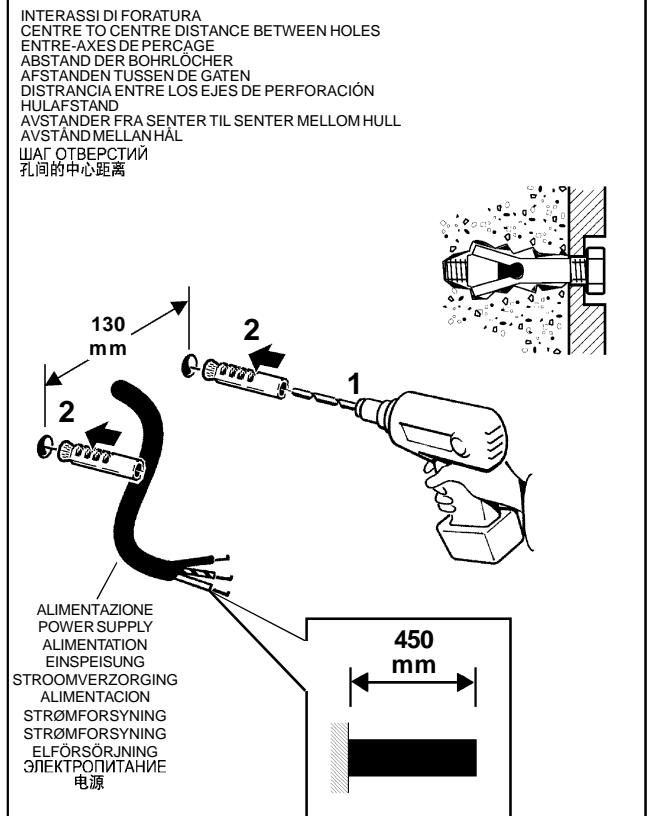

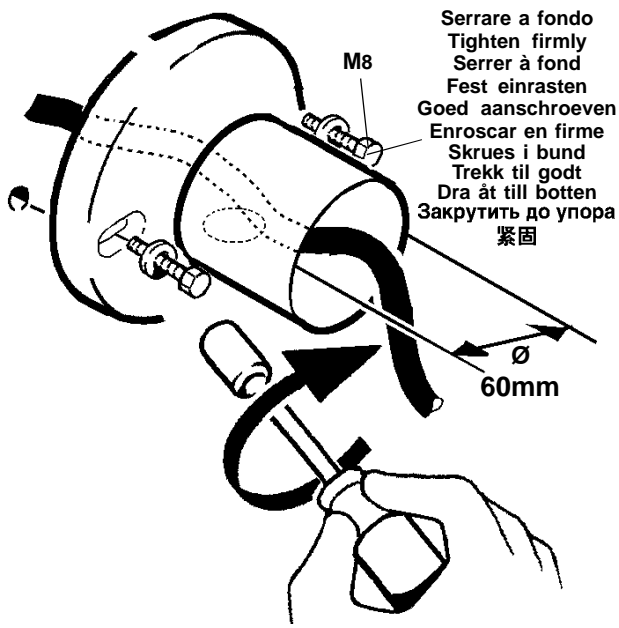

Serrare a fondo  
Tighten firmly  
Serrer à fond  
Fest einrasten  
Goed aanschroeven  
Enrosca en firme  
Skrues i bund  
Trekk til godt  
Dra åt till botten  
Закрутить до упора  
紧固

60mm

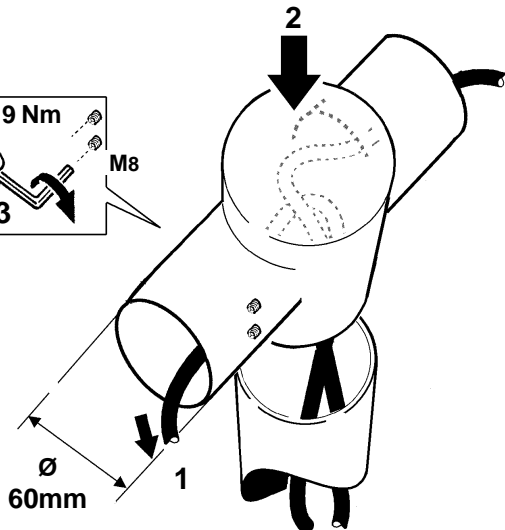
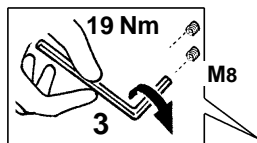
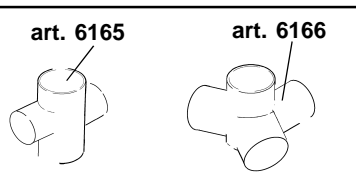
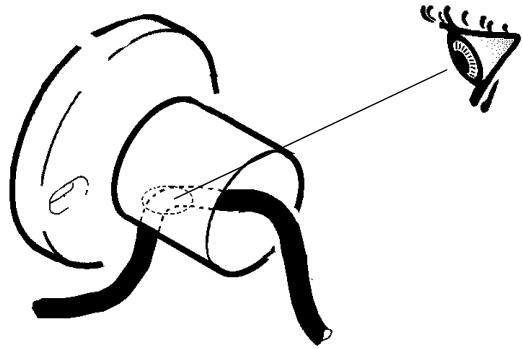

3



INSTALLAZIONE SU PALO CON L' ART. 6156 - 6159  
POLE APPLICATION WITH ART. 6156 - 6159  
INSTALLATION SUR MÂT AVEC L' ART. 6156 - 6159  
MASTINSTALLATION MIT DEM ART. 6156 - 6159  
INSTALLATIE OP PAAL MET ART. 6156 - 6159  
INSTALACION EN POSTE CON ART. 6156 - 6159  
INSTALLATION PÅ MAST MED ART. 6156 - 6159  
STANGAPPLIKASJON MED ART. 6156 - 6159  
INSTALLATION PÅ STOLPE MED ART. 6156 - 6159  
МОНТАЖ НА ФОНАРНОМ СТОЛБЕ С АРТИКЛЕМ ART. 6156 - 6159  
ART. 6156 - 6159 杆式

ART.	PALO - POLE - MAT MAST - PAAL - POSTE ФОНАРНЫЙ СТОЛБ 灯杆 Ø mm	ART.	PALO - POLE - MAT MAST - PAAL - POSTE ФОНАРНЫЙ СТОЛБ 灯杆 Ø mm
6161	102	6156	102
6162	120	6159	120

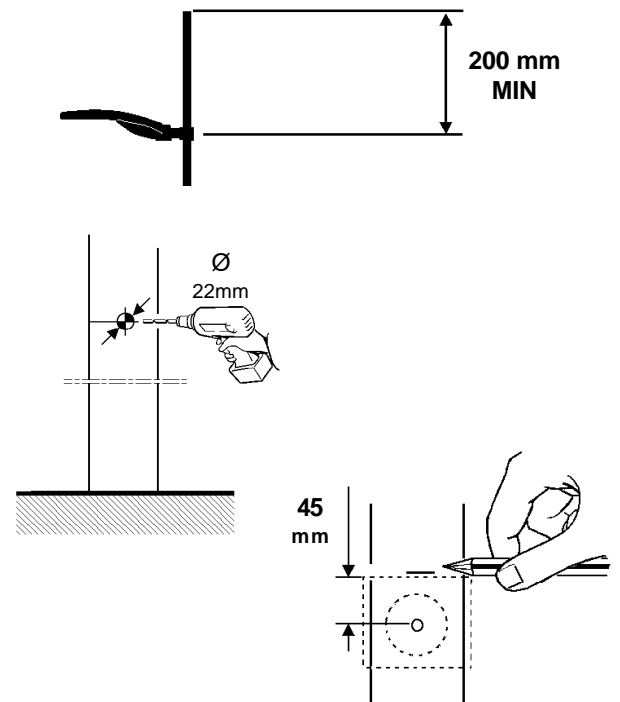

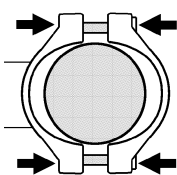
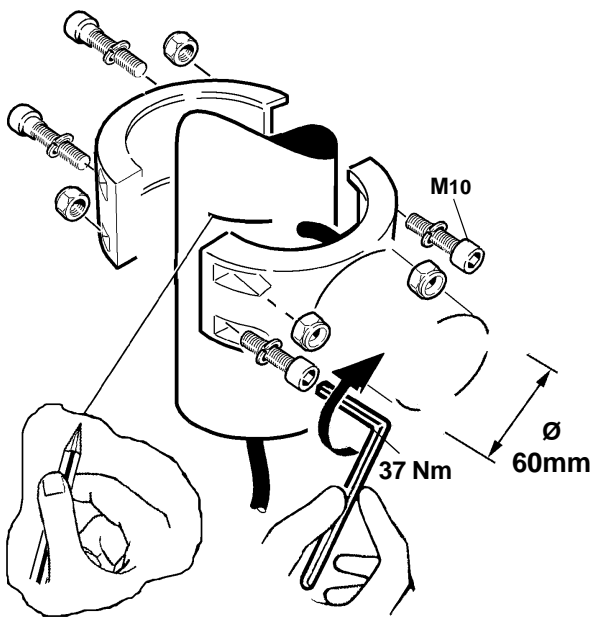
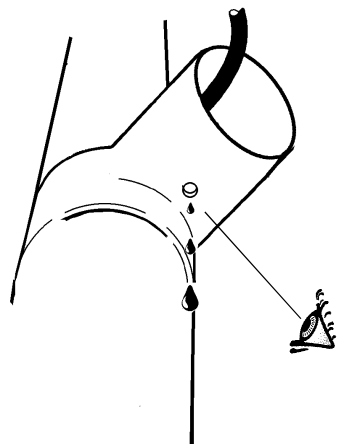
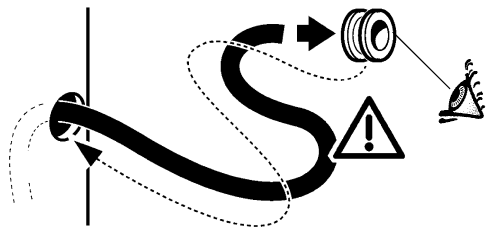

**OK**

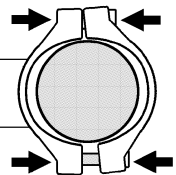

**NO**

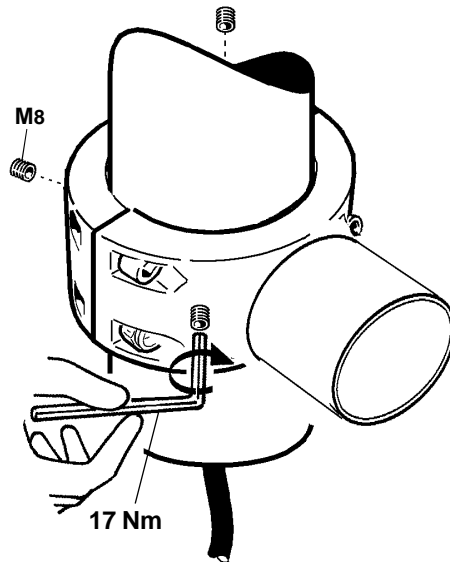

INSTALLAZIONE SU PALO CON L' ART. 6155 - 6158  
 POLE APPLICATION WITH ART.6155 - 6158  
 INSTALLATION SUR MÂT AVEC L' ART. 6155 - 6158  
 MASTINSTALLATION MIT DEM ART. 6155 - 6158  
 INSTALLATIE OP PAAL MET ART. 6155 - 6158  
 INSTALACIÓN EN POSTE CON ART. 6155 - 6158  
 INSTALLATION PÅ MAST MED ART. 6155 - 6158  
 STANGAPPLIKASJON MED ART. 6155 - 6158  
 INSTALLATION PÅ STOLPE MED ART. 6155 - 6158  
 МОНТАЖ НА ФОНАРНОМ СТОЛБЕ С АРТИКЛЕМ ART. 6155 - 6158  
 ART. 6155 - 6158 杆式

ART.	PALO - POLE - MAT MAST - PAAL - POSTE ФОНАРНЫЙ СТОЛБ 灯杆 Ø mm	ART.	PALO - POLE - MAT MAST - PAAL - POSTE ФОНАРНЫЙ СТОЛБ 灯杆 Ø mm
6161	102	6155	102
6162	120	6158	120

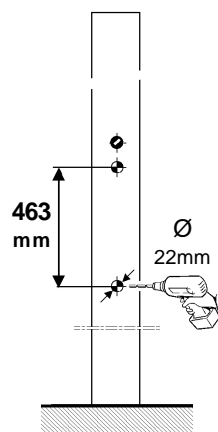
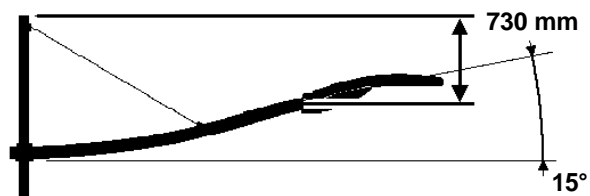

45 mm

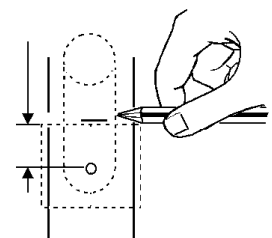

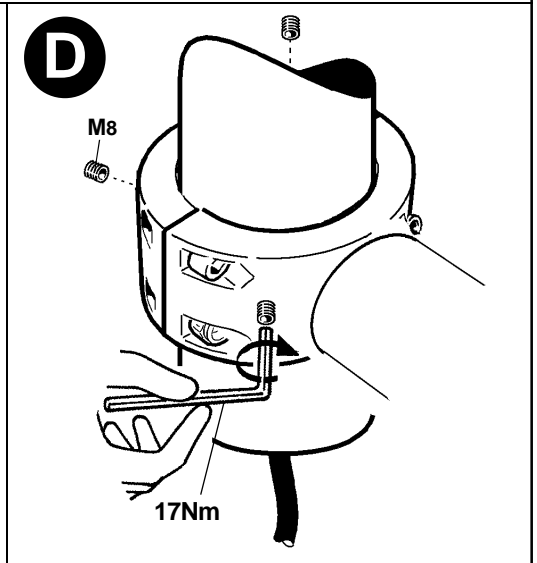
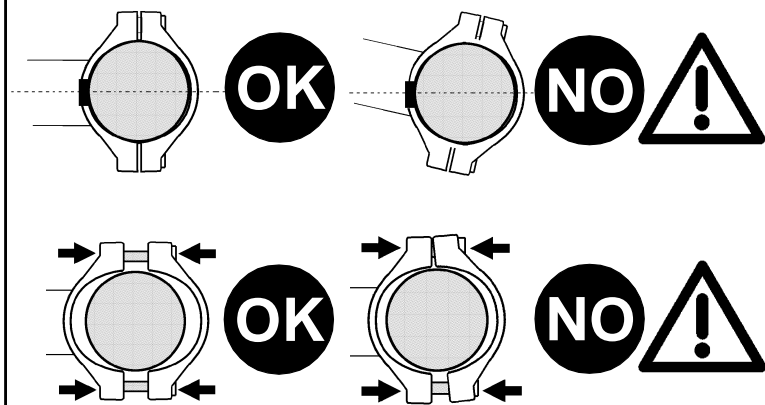
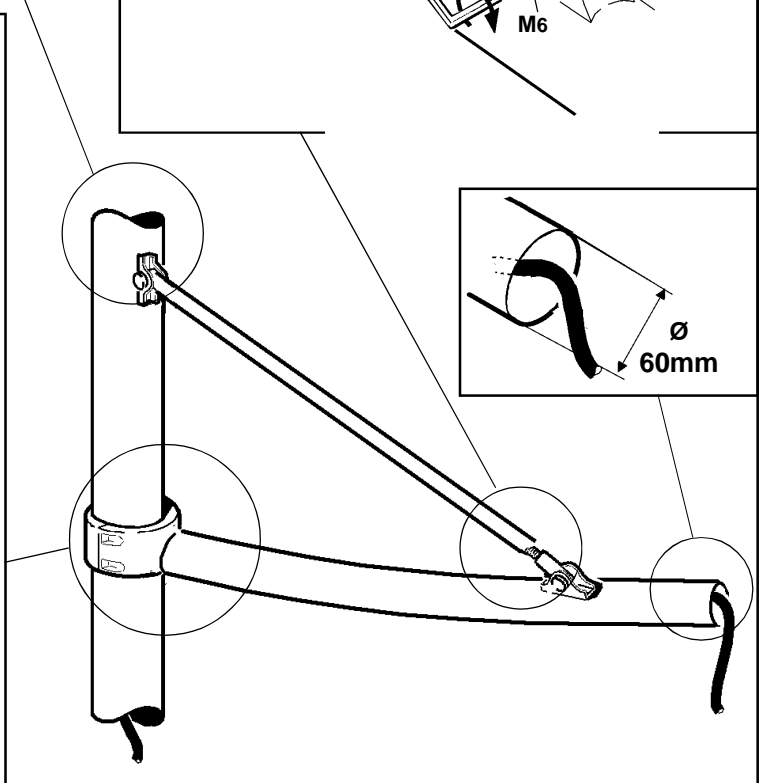
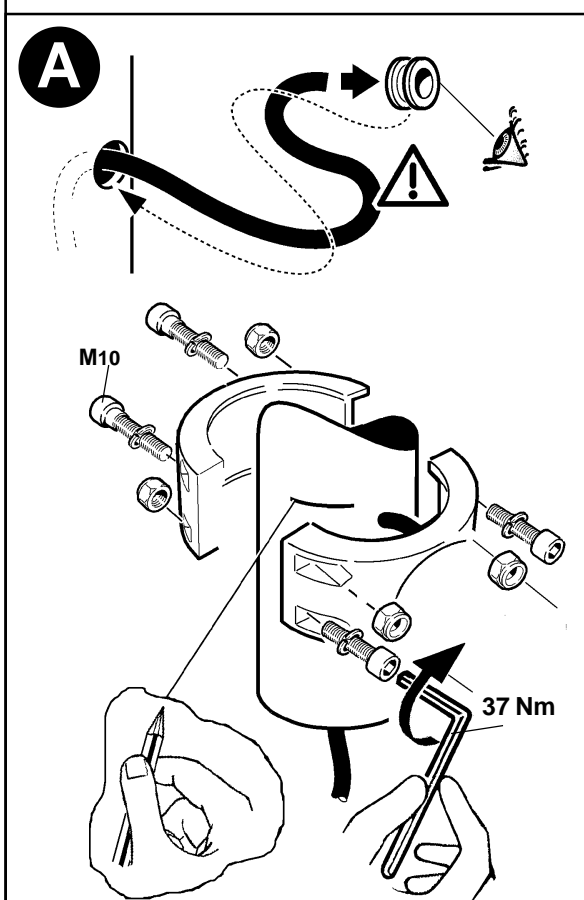
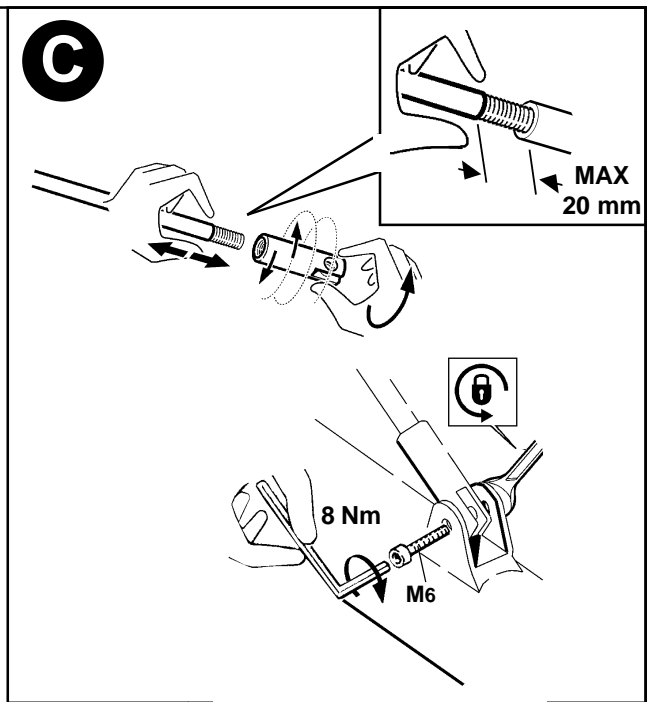
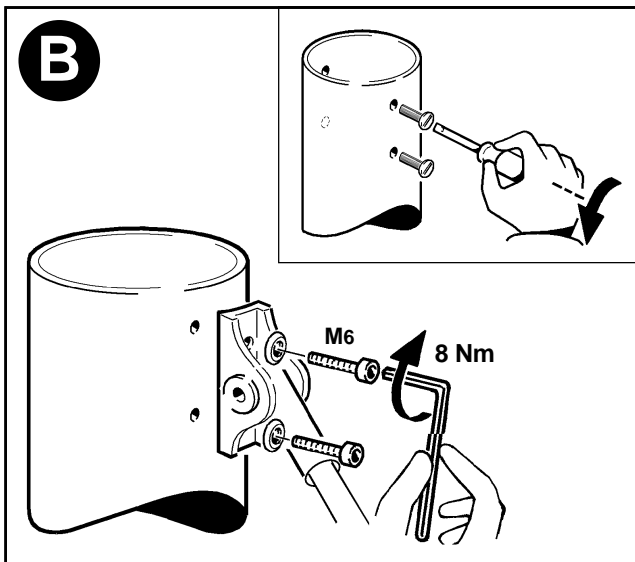

INSTALLAZIONE SU PALO CON L' ART. 6154 - 6157  
 POLE APPLICATION WITH ART. 6154 - 6157  
 INSTALLATION SUR MÂT AVEC L' ART. 6154 - 6157  
 MASTINSTALLATION MIT DEM ART. 6154 - 6157  
 INSTALLATIE OP PAAL MET ART. 6154 - 6157  
 INSTALACIÓN EN POSTE CON ART. 6154 - 6157  
 INSTALLATION PÅ MAST MED ART. 6154 - 6157  
 STANGAPPLIKASJON MED ART. 6154 - 6157  
 INSTALLATION PÅ STOLPE MED ART. 6154 - 6157  
 МОНТАЖ НА ФОНАРНОМ СТОЛБЕ С АРТИКЛЕМ ART. 6154 - 6157  
 ART. 6154 - 6157 杆式

INTERASSI DI FORATURA  
 CENTRE TO CENTRE DISTANCE BETWEEN HOLES  
 ENTRE-AXES DE PERÇAGE  
 ABSTAND DER BOHRLÖCHER  
 AFSTANDEN TUSSEN DE GATEN  
 DISTANCIA ENTRE LOS EJES DE PERFORACIÓN  
 HULAFSTAND  
 AVSTANDER FRA SENTER TIL SENTER MELLOM HULL  
 AVSTÅND MELLAN HÅL  
 ШАГ ОТВЕРСТИЙ  
 孔间的中心距离

ART.	PALO - POLE - MAST MAST - PAAL - POSTE ФОНАРНЫЙ СТОЛБ 灯杆 Ø mm	ART.	PALO - POLE - MAST MAST - PAAL - POSTE ФОНАРНЫЙ СТОЛБ 灯杆 Ø mm
6161	102	6154	102
6162	120	6157	120

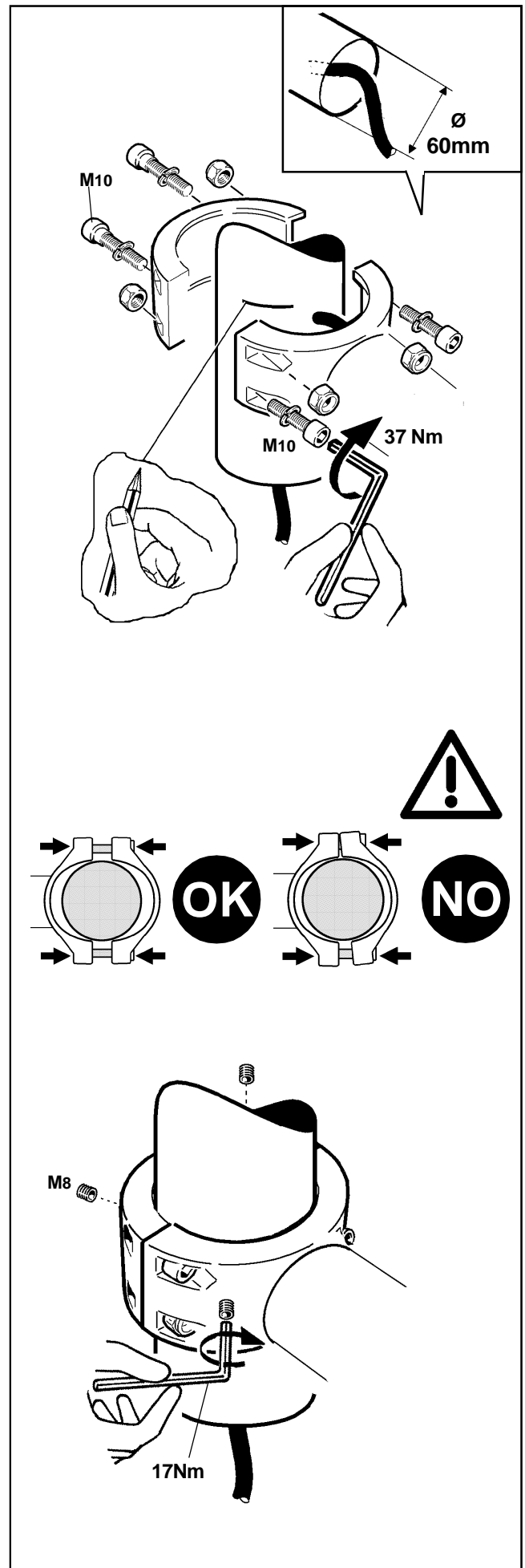
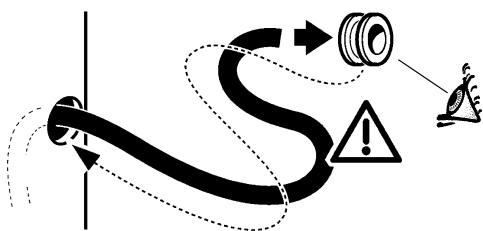
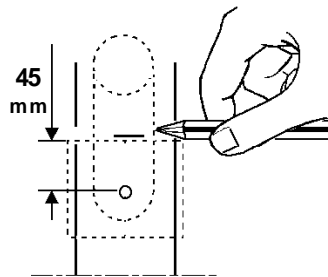
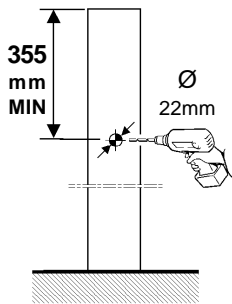
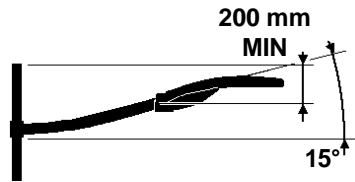

# ART. 6163 - 6164

ART.	PALO - POLE - MAT MAST - PAAL - POSTE ФОНАРНЫЙ СТОЛБ 灯杆 Ø mm
6163	89
6164	114

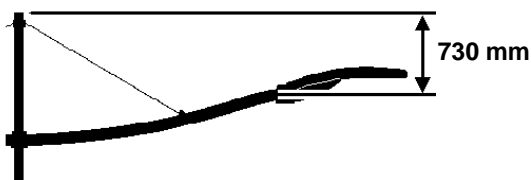
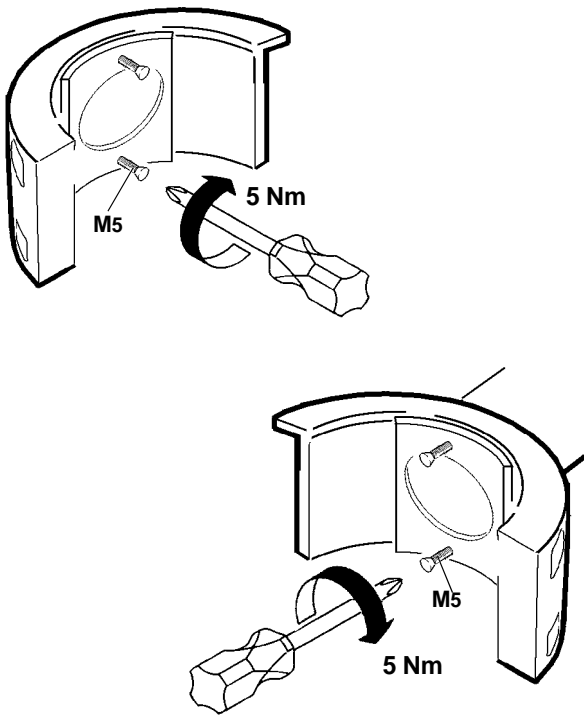

art.6163+6155

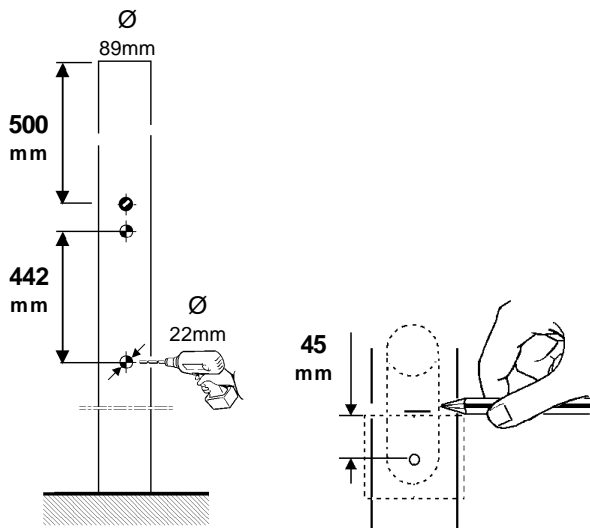

art.6164+6158

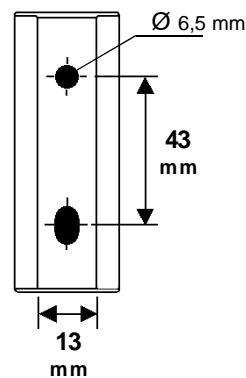
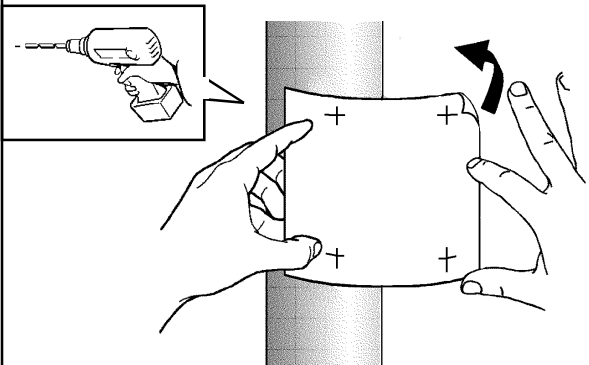
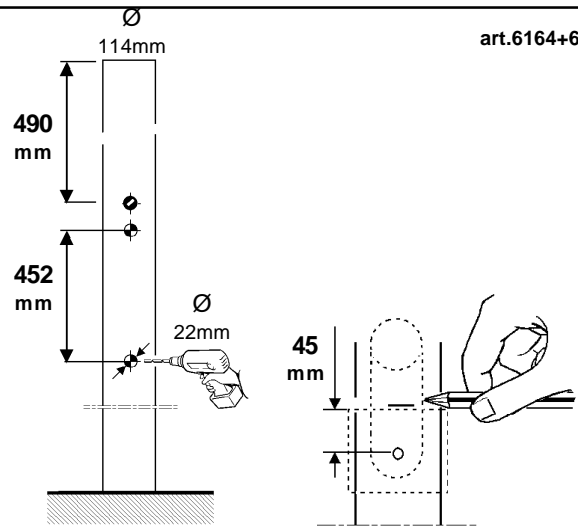

- I Per il cablaggio elettrico fare riferimento al foglio istruzioni del vano ottico.
- GB Please refer to the optical assembly instruction sheet for the electric wiring.
- F Pour le câblage électrique, se reporter à la notice d'instructions du groupe optique.
- D Informationen zur elektrischen Verkabelung können Sie den Hinweisen zum Leuchtengehäuse entnehmen.
- NL Voor de elektrische bedrading raadpleegt u het instructiebladje in het armatuur.
- E Para el cableado eléctrico hágase referencia a la hoja de instrucciones del vano óptico.
- DK Se vejledningerne til den optiske enhed for ledningsføring.
- N Vennligst se instruksjonsarket for den optiske monteringen for den elektriske kablingen.
- S Angående kabeldragningen, se instruktionsbladet för det optiska rummet.
- RUS Порядок монтажа электропроводки смотрите в инструкциях к ламповому отсеку.
- CN 针对布线，请参阅光学组件说明表。

## Sistemi di installazione

تحذير :

AR لا يمكن ضمان سلامة هذا الجهاز إلا إذا التزمت بهذه التعليمات. يجب حفظها في مكان آمن.

**IT ATTENZIONE:**

LA SICUREZZA DELL'APPARECCHIO E' GARANTITA SOLO CON L'USO APPROPRIATO DELLE SEGUENTI ISTRUZIONI; PERTANTO E' NECESSARIO CONSERVARLE.

**EN WARNING:**

THE SAFETY OF THIS FIXTURE IS GUARANTEED ONLY IF YOU COMPLY WITH THESE INSTRUCTIONS; REMEMBER TO CONSERVE IN A SAFE PLACE.

**ES ATENCION:**

LA SEGURIDAD DEL APARATO SE GARANTIZA SOLO CUMPLIENDO CUIDADOSAMENTE LAS SIGUIENTES INSTRUCCIONES; POR ELLO, ES NECESARIO CONSERVARLAS.

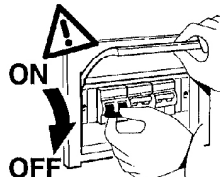

AR ملاحظة: ملاحظة: أثناء تركيب نظام . يجب التقيد بحرص بالنظم السائدة المتعلقة بالشبكة الكهربائية.

IT N.B.: DURANTE L'INSTALLAZIONE DEL SISTEMA RISPETTARE SCRUPolosAMENTE LE NORME IMPIANTISTICHE VIGENTI.

EN N.B.: WHEN INSTALLING THE SYSTEM STRICTLY COMPLY WITH ALL REGULATIONS ON INSTALLATION IN FORCE.

ES N.B.: DURANTE LA INSTALACIÓN DEL SISTEMA RESPETAR ESCRUPolosAMENTE LAS NORMAS DE INSTALACIÓN VIGENTES.

## WOW

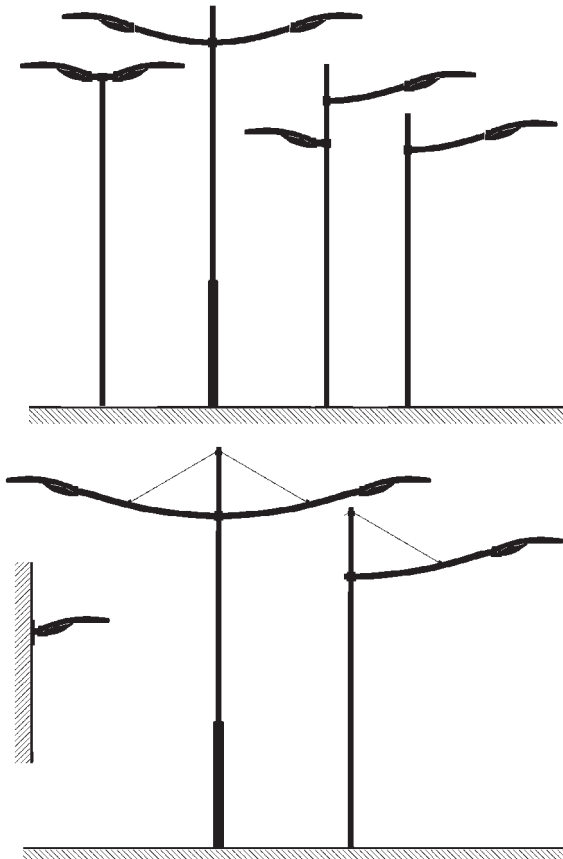

## STREET

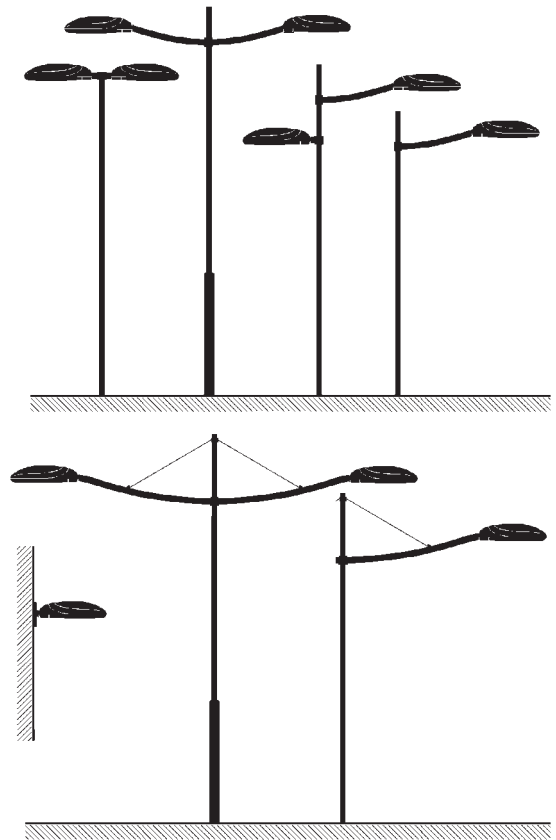

## ARCHILEDE

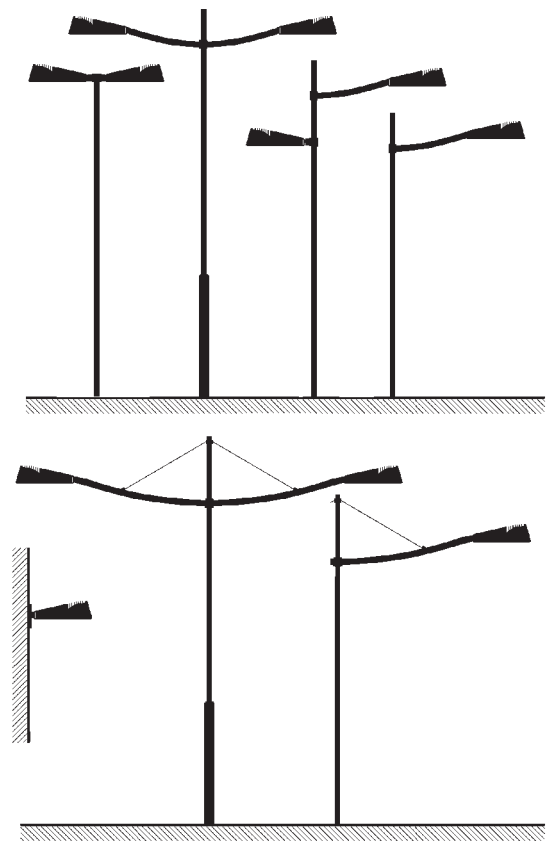



## تركيب على جدار مع السلعة 6160

INSTALLAZIONE AD APPLIQUE CON L' ART. 6160  
WALL APPLICATION WITH ART. 6160  
INSTALACIÓN EN PARED CON ART. 6160

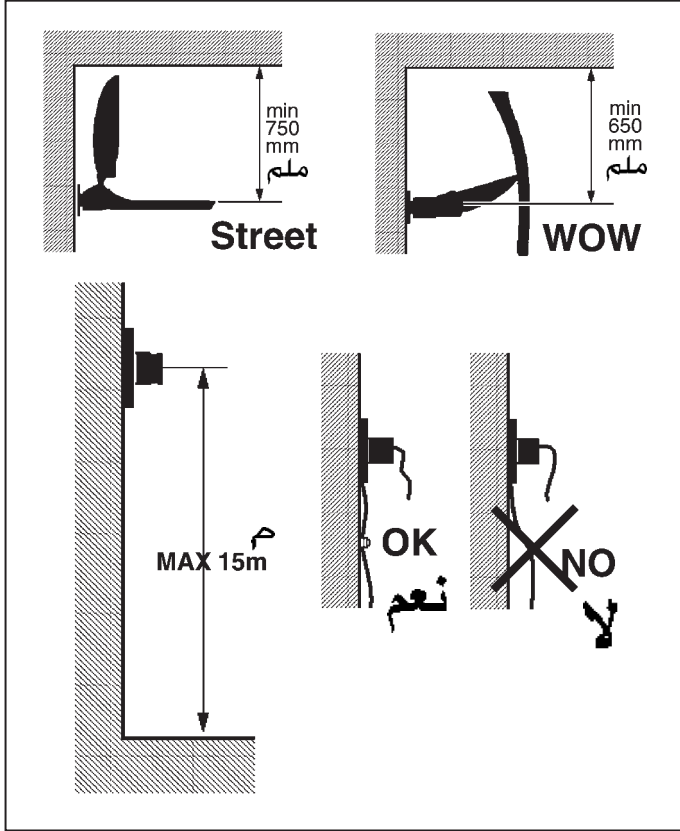

يجب مراعاة عدم تأثير وزن الكبل أو شدته بشكل عفوي على المنتج. عر  
ملاحظة: \* يجب عدم التفتد بقوة تزيد عن 80 نيوتن.

IT Evitare che il peso del cavo o sue trazioni accidentali gravino sul prodotto.  
N.B.:\*Non sottoporre a trazioni superiori agli 80 N.

EN The cable weighing on the product or being accidentally tugged may cause damage to the product. Avoid both.  
N.B.:\*Do not subject to tugs greater than 80 N.

ES Evitar cargar el peso del cable o sus tracciones accidentales sobre el producto.  
NOTA:\*No someter a tracciones superiores a 80 N.

استعمل مسامير لولبية امتدادية مع براغي M8 عند تثبيت المنتج.  
ينم اختيار المسامير اللولبية المطلوب استعماله انيايلون وفولاذ ويتفاعل  
كيمياوي ... حسب مواصفات المادة المكون منها السطح الإستنادي (حجر،  
خرسانة، معدن ...) الذي يركب عليه المنتج.

PER IL FISSAGGIO USARE TASSELLI AD ESPANSIONE CON VITI M 8; IL TIPO DI TASSELLO DA USARE (NYLON, ACCIAIO, A REAZIONE CHIMICA ...) E' DA SCEGLIERE IN FUNZIONE DELLE CARATTERISTICHE DEL MATERIALE DI SUPPORTO (MURATURA, CALCESTRUZZO, METALLO ...) SU CUI VIENE APPLICATO IL PRODOTTO.

FOR ATTACHMENT, USE EXPANSION PLUGS WITH M8 SCREW; CHOOSE THE TYPE OF PLUG (NYLON, STEEL, CHEMICAL REACTION ...) ACCORDING TO THE CHARACTERISTICS OF THE SURFACE (MASONRY, CONCRETE, METAL ...) TO WHICH IT IS APPLIED.

PARA LA FIJACION UTILIZAR TARUGOS DE EXPANSION CON TORNILLOS M 8; EL TIPO DE TARUGO QUE DEBE USARSE ( NYLON, ACERO, DE REACCION QUIMICA ...) DEBERA ELEGIRSE EN FUNCION DE LAS CARACTERISTICAS DEL MATERIAL DE SOPORTE ( MAMPOSTERIA, HORMIGON, METAL ...) EN EL CUAL DEBE APLICARSE EL PRODUCTO.

## المسافة بين مراكز الثقوب

INTERASSI DI FORATURA  
CENTRE TO CENTRE DISTANCE BETWEEN HOLES  
DISTANCIA ENTRE LOS EJES DE PERFORACIÓN

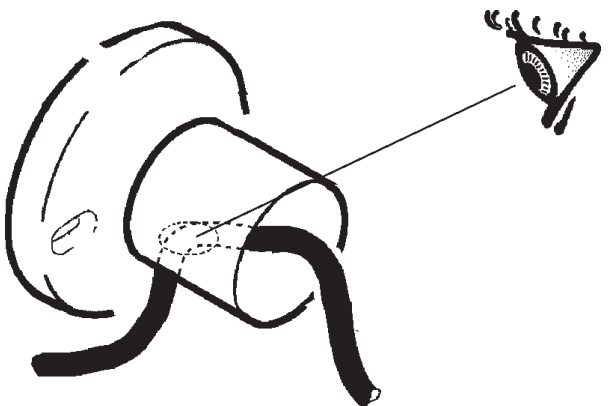
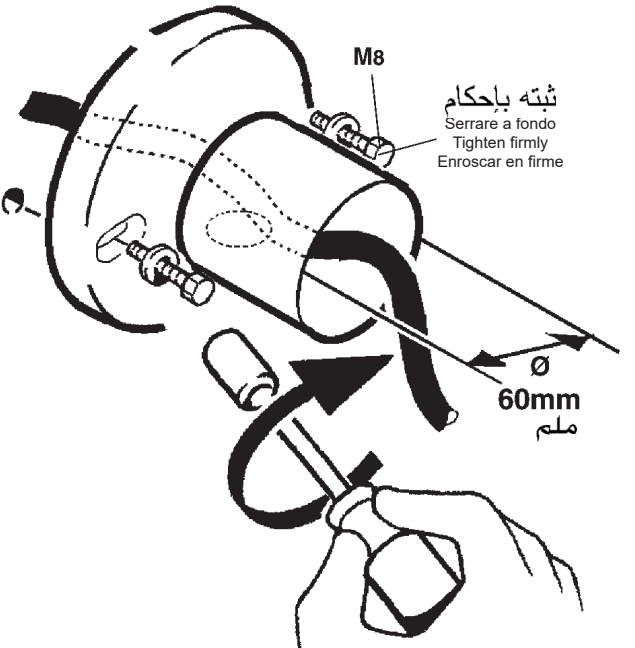
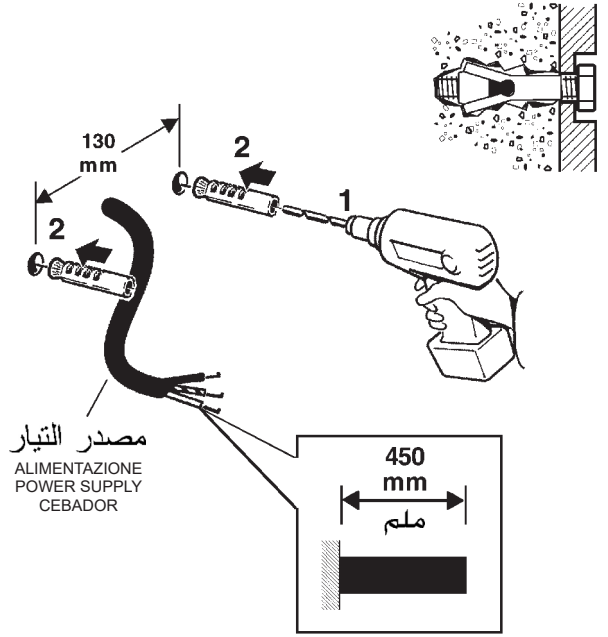

تركيب على عمود مع الساعة 6156 - 6159

INSTALLAZIONE SU PALO CON L' ART. 6156 - 6159

POLE APPLICATION WITH ART. 6156 - 6159

INSTALACIÓN EN POSTE CON ART. 6156 - 6159

ART. الصنف	عمود PALO - POLE - POSTE Ø mm ملم	ART. الصنف	عمود PALO - POLE - POSTE Ø mm ملم
6161	102	6156	102
6162	120	6159	120

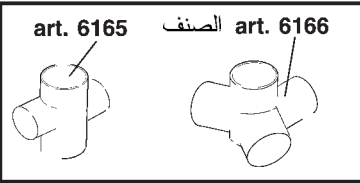

19 نيوتن متر

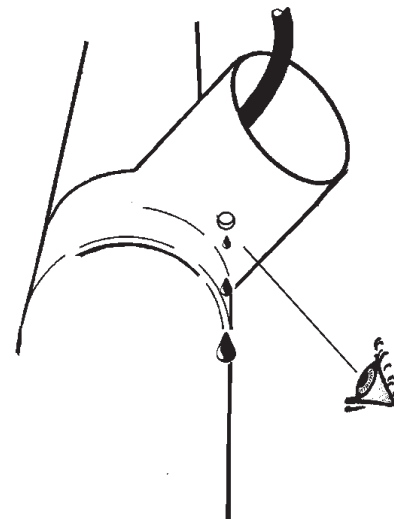
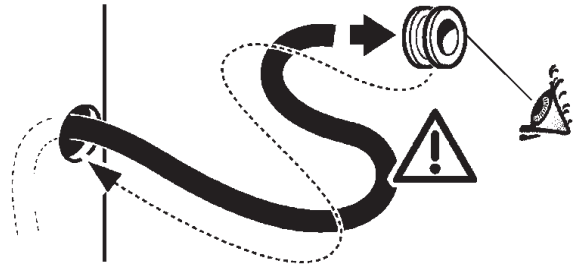
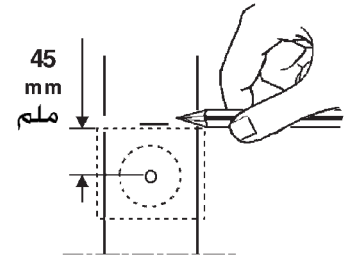
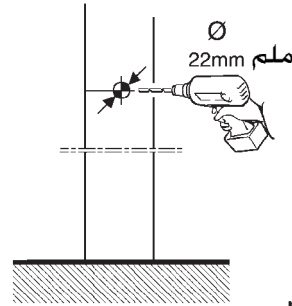
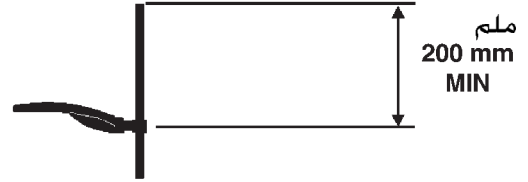
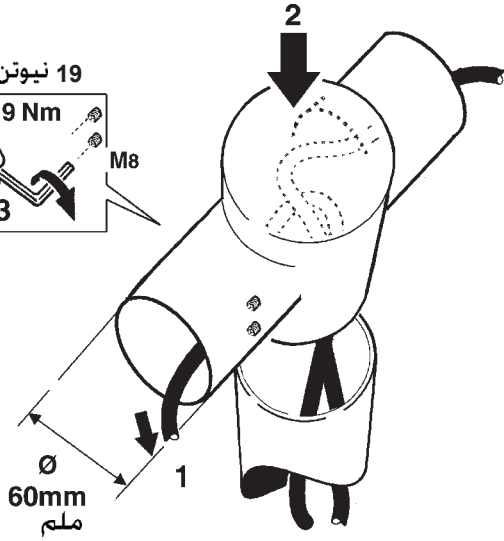
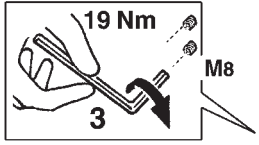

تركيب على عمود مع السلعة 6155 - 6158

INSTALLAZIONE SU PALO CON L' ART. 6155 - 6158

POLE APPLICATION WITH ART. 6155 - 6158

INSTALACIÓN EN POSTE CON ART. 6155 - 6158

ART. الصنف	عمود PALO - POLE - POSTE Ø mm ملم	ART. الصنف	عمود PALO - POLE - POSTE Ø mm ملم
6161	102	6155	102
6162	120	6158	120

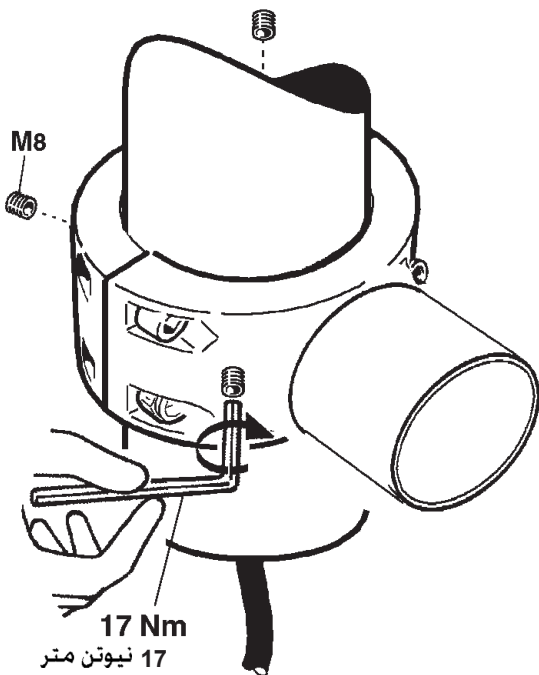
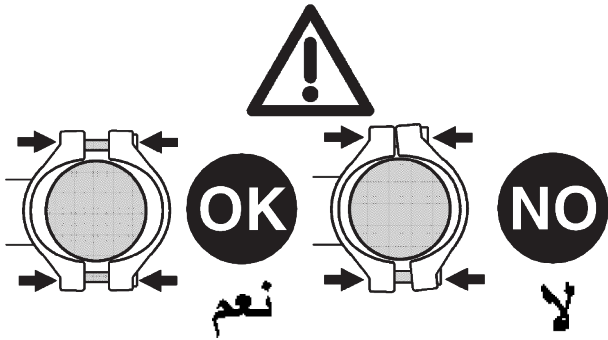
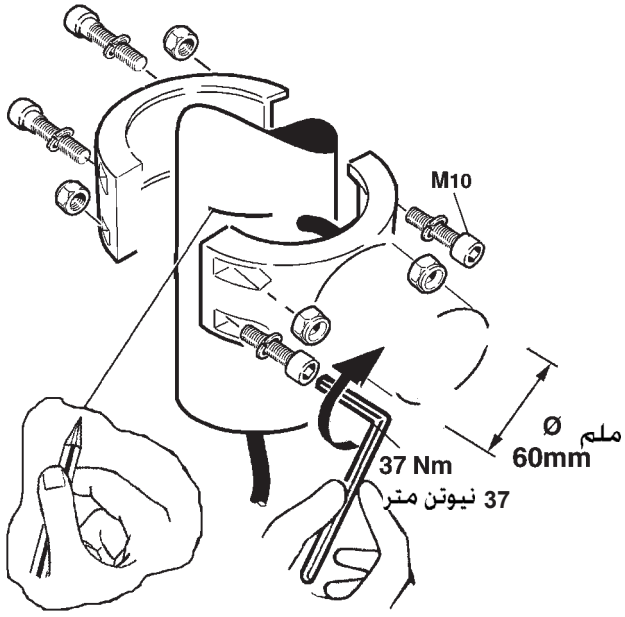
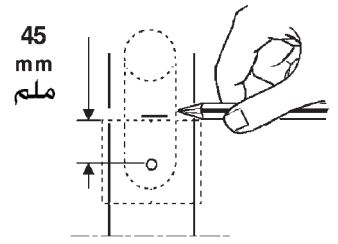
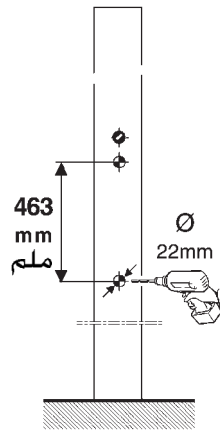
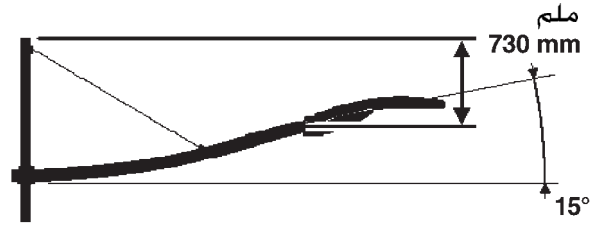

**B**

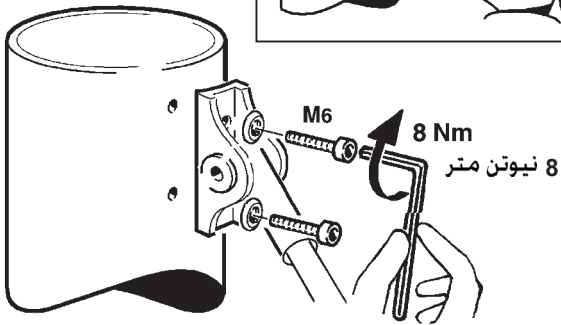
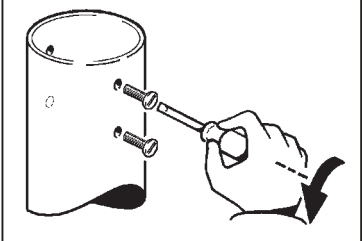

**C**

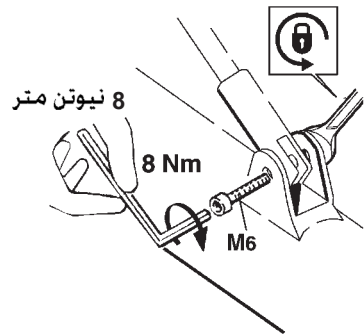
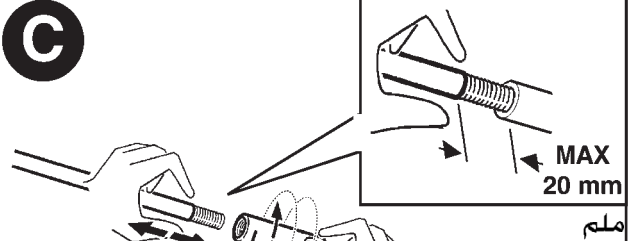

**A**

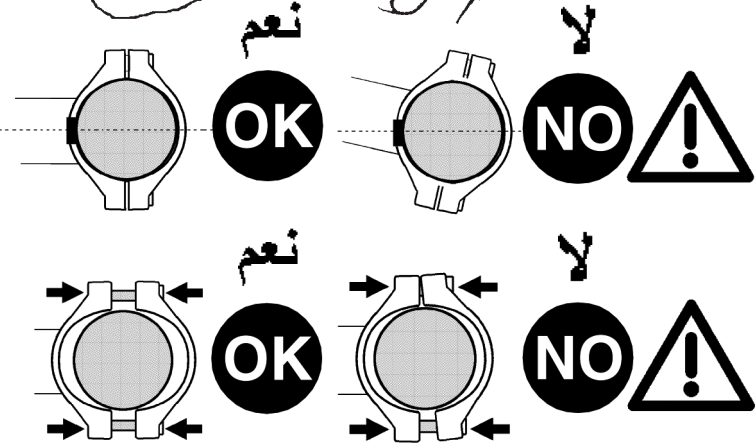
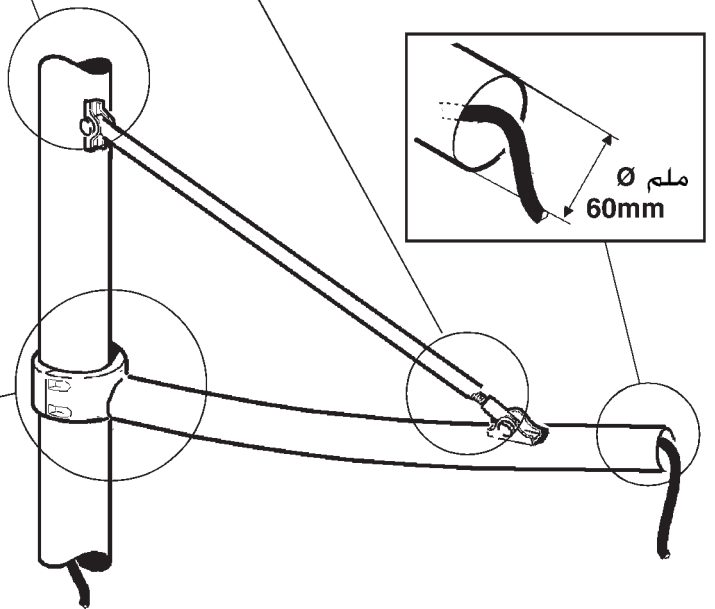
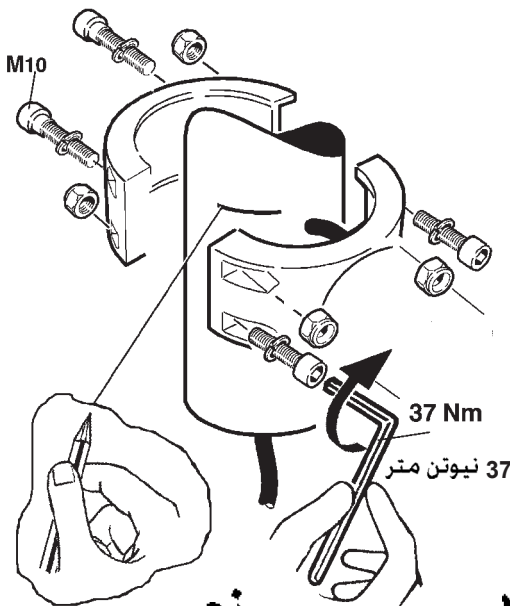
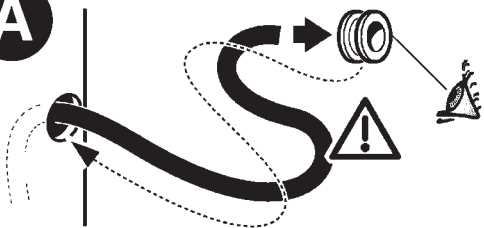

**D**

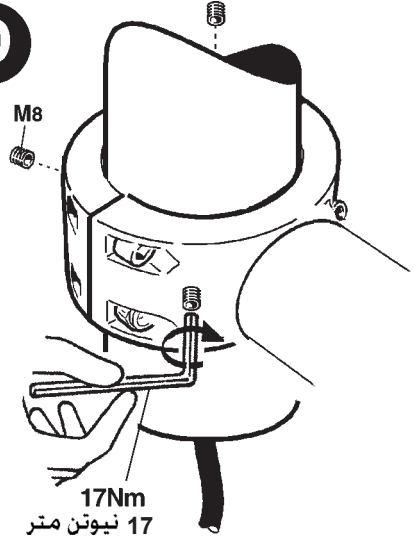

تركيب على عمود مع السلعة 6154 - 6157

INSTALLAZIONE SU PALO CON L' ART. 6154 - 6157

POLE APPLICATION WITH ART. 6154 - 6157

INSTALACIÓN EN POSTE CON ART. 6154 - 6157

المسافة بين مراكز الثقوب

INTERASSI DI FORATURA  
CENTRE TO CENTRE DISTANCE BETWEEN HOLES  
DISTANCIA ENTRE LOS EJES DE PERFORACIÓN

ART. الصف	عمود PALO - POLE - POSTE Ø mm ملم
6161	102
6162	120

ART. الصف	عمود PALO - POLE - POSTE Ø mm ملم
6154	102
6157	120

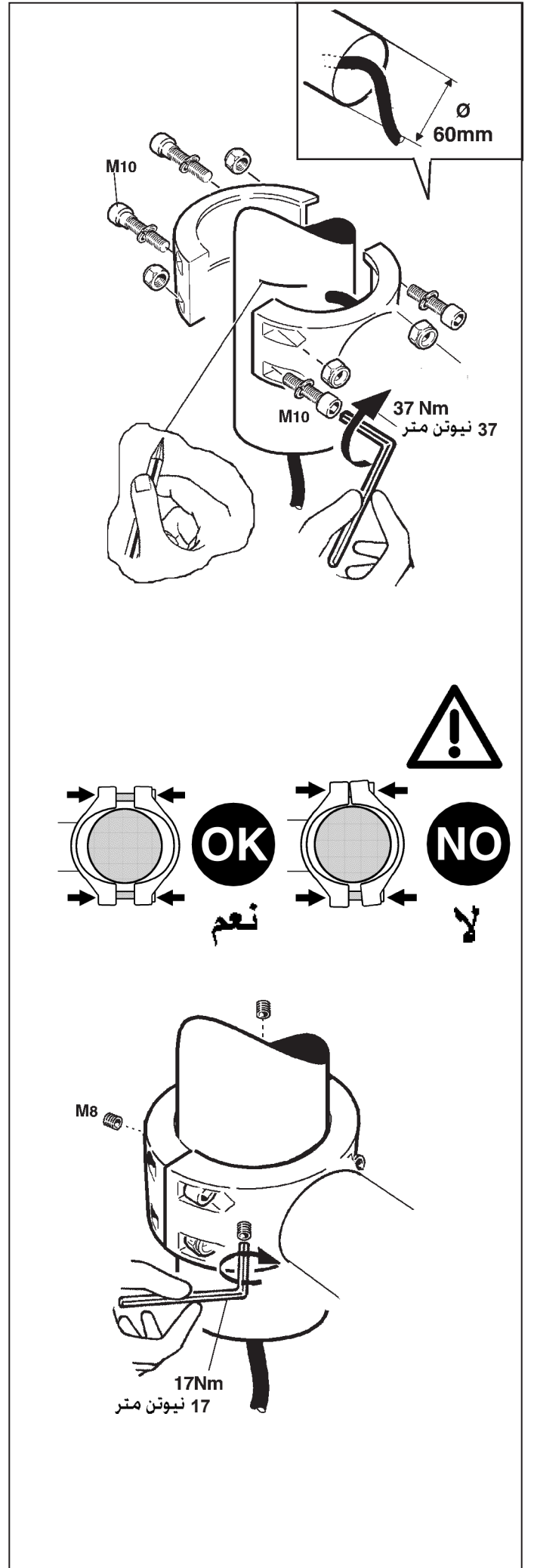
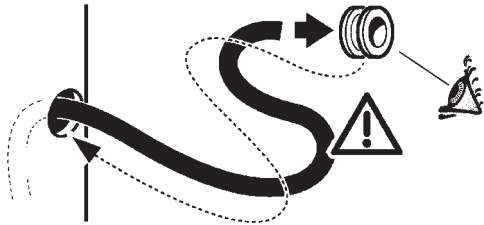
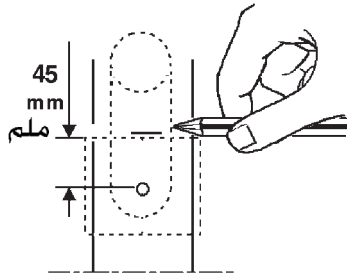
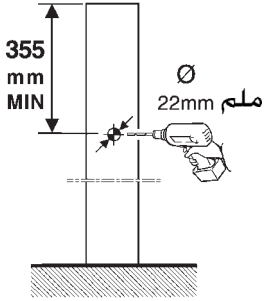

# ART. 6163 - 6164

ART. الصف	عمود PALO - POLE - POSTE Ø mm ملم
6163	89
6164	114

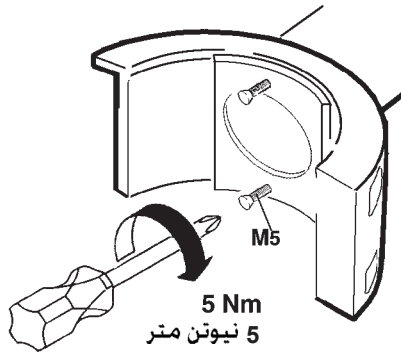
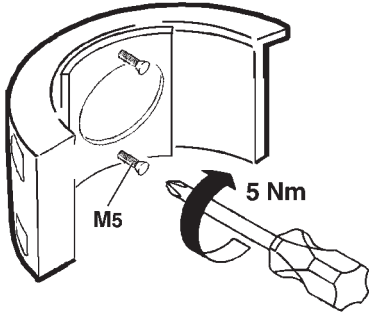

## الصف art. 6163 + 6155

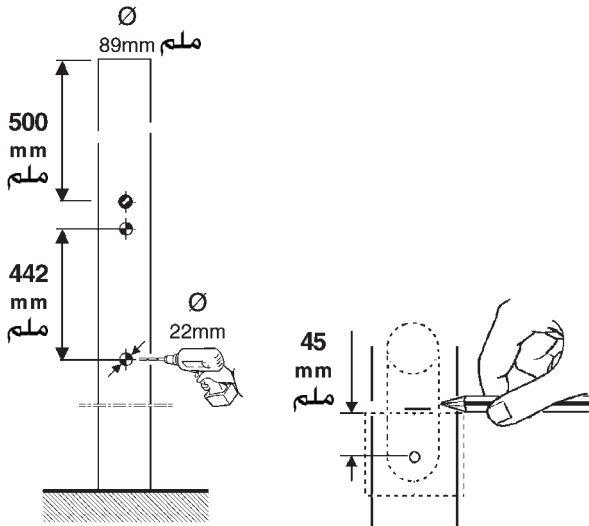

## الصف art. 6164 + 6158

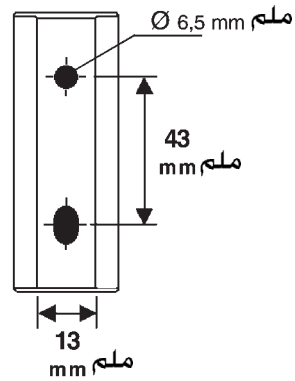
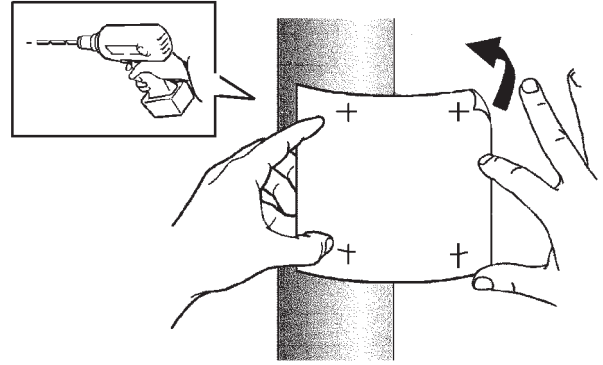
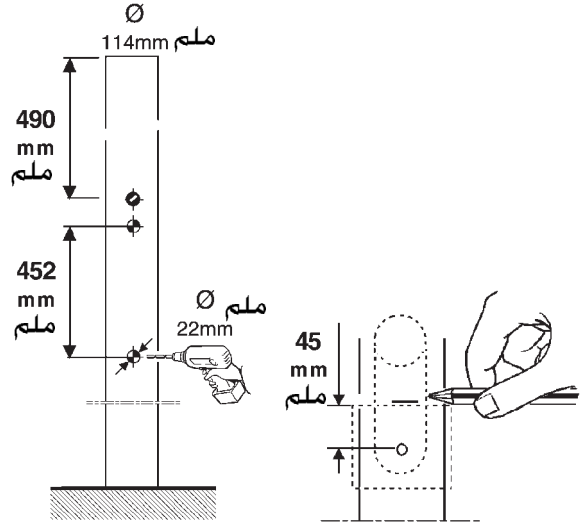

- AR بفصوص التسيانك الكهربائي، راجع ورقة التعليمات الخاصة بالحجرة البصرية.
- IT Per il cablaggio elettrico fare riferimento al foglio istruzioni del vano ottico.
- EN Please refer to the optical assembly instruction sheet for the electric wiring.
- ES Para el cableado eléctrico hágase referencia a la hoja de instrucciones del vano óptico.