

iGuzzini BLADE "R" MINIMAL

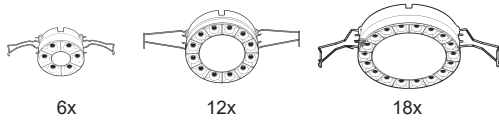

HIGH CONTRAST



IT ATTENZIONE:

LA SICUREZZA DELL'APPARECCHIO E' GARANTITA SOLO CON L'USO APPROPRIATO DELLE SEGUENTI ISTRUZIONI; PERTANTO E' NECESSARIO CONSERVARLE.

EN WARNING:

THE SAFETY OF THIS FIXTURE IS GUARANTEED ONLY IF YOU COMPLY WITH THESE INSTRUCTIONS; REMEMBER TO CONSERVE IN A SAFE PLACE.

FR ATTENTION:

LA SÉCURITÉ DE L'APPAREIL N'EST GARANTIE QU'EN CAS D'UTILISATION CORRECTE DES INSTRUCTIONS SUIVANTES; IL FAUT PAR CONSÉQUENT LES CONSERVER.

DE ACHTUNG:

DIE SICHERHEIT DES GERÄTES WIRD NUR DURCH SACHGEMÄSSE BEFOLGUNG NACHSTEHENDER ANWEISUNGEN GEWÄHRLEISTET; IHRE AUFBEWAHRUNG IST DESHALB SEHR WICHTIG.

NL OPGELET:

DE VEILIGHEID VAN DI ATOESTEL IS SLECHTS DAN GEGARANDEERD ALS INDIEN DE VOLGENDE INSTRUCTIES STRIKT WORDEN TOEGEPAST: DAAROM MOET MEN ZE OOK BEWAREN.

ES ATENCION:

LA SEGURIDAD DEL APARATO SE GARANTIZA SOLO CUMPLIENDO CUIDADOSAMENTE LAS SIGUIENTES INSTRUCCIONES; POR ELLO, ES NECESARIO CONSERVARLAS.

DA BEMÆRK:

SIKKERHEDEN VED BRUG AF ARMATURET KAN KUN GARANTERES, HVIS DISSE ANVISNINGER FØLGES; SØRG DERFOR FOR AT GEMME DEM.

NO ADVARSEL:

SIKKERHETEN TIL DETTE APPARATET GARANTERES KUN HVIS DU OVERHOLDER DISSE INSTRUKSJONENE; HUSK Å OPPBEVARE DEM PÅ ET TRYGT STED.

SV OBSERVERA!

UTRUSTNINGENS SÄKERHET KAN ENDAST GARANTERAS OM DESSA ANVISNINGAR RESPEKTERAS I DETALJ. SPARA DÄRFÖR DESSA ANVISNINGAR FÖR FRAMTIDA KONSULTATION.

RU ВНИМАНИЕ:

МЫ ГАРАНТИРУЕМ БЕЗОПАСНУЮ ЭКСПЛУАТАЦИЮ ИЗДЕЛИЯ ТОЛЬКО ПРИ СОБЛЮДЕНИИ СЛЕДУЮЩИХ ИНСТРУКЦИЙ; С ЭТОЙ ЦЕЛЬЮ НЕОБХОДИМО СОХРАНИТЬ ДАННУЮ БРОШЮРУ.

ZH 警告

为确保该装置安全，请遵守操作指示；并于安全场所放置。

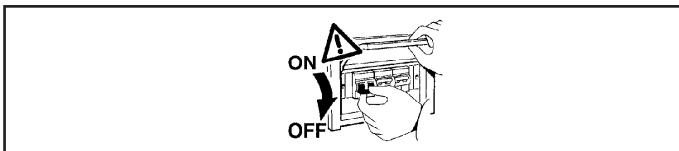

N.B.: DURANTE L'INSTALLAZIONE DEL SISTEMA RISPETTARE SCRUPolosAMENTE LE NORME IMPIANTISTICHE VIGENTI.

N.B.: WHEN INSTALLING THE SYSTEM, STRICTLY COMPLY WITH ALL REGULATIONS ON INSTALLATION IN FORCE.

N.B.: LORS DE L'INSTALLATION DU SYSTÈME VEUILLEZ RESPECTER RIGOREUSEMENT LES NORMES EN VIGUEUR EN LA MATIÈRE.

NB: BEACHTEN SIE BEI DER INSTALLATION DES SYSTEMS GEWISSENHAFT DIE GÜLTIGEN BESTIMMUNGEN BEZÜGLICH DER ANLAGENTECHNIK.

N.B.: BIJ HET INSTALLEREN VAN HET SYSTEEM MOET U DE GELDEN DE INSTALLATIE-NORMEN STRIKT NALEVEN.

N.B.: DURANTE LA INSTALACIÓN DEL SISTEMA RESPETAR E SCRUPolosAMENTE LAS NORMAS DE INSTALACIÓN VIGENTES.

N.B.: UNDER INSTALLATION AF SYSTEMET SKAL MAN NØJE OVERHOLDE DE GÆLDENDE REGLER FOR DISSE ANLÆG.

N.B.: VED INSTALLASJON AV SYSTEMET SKAL ALLE FORSKRIFTER OM INSTALLASJON SOM GJELDER FØLGES STRENGT.

OBS! UNDER INSTALLATIONEN AV SYSTEMET SKA INSTALLATIONSFÖRESKRIFTERNA RESPEKTERAS I DETALJ.

ПРИМЕЧАНИЕ: В ПРОЦЕССЕ МОНТАЖА СИСТЕМЫ СТРОГО СОБЛЮДАЙТЕ НАЦИОНАЛЬНЫЕ ДЕЙСТВУЮЩИЕ НОРМАТИВЫ ПО ЭЛЕКТРОПРОВОДКЕ.

注意：在安装系统时请遵守设备的安装规定。

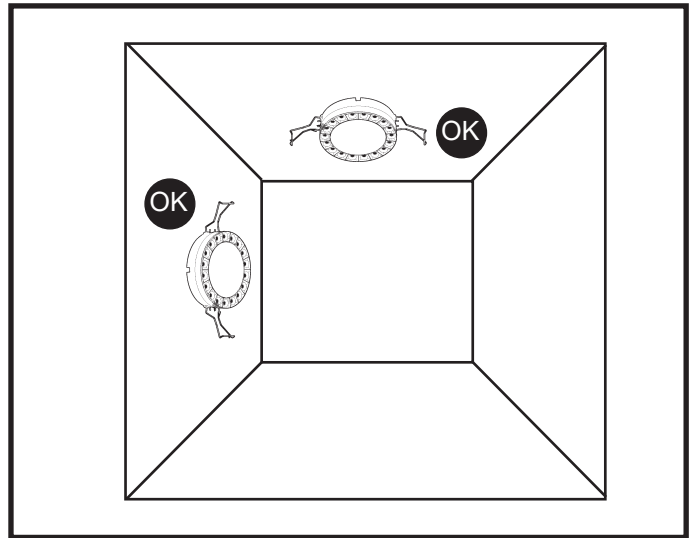
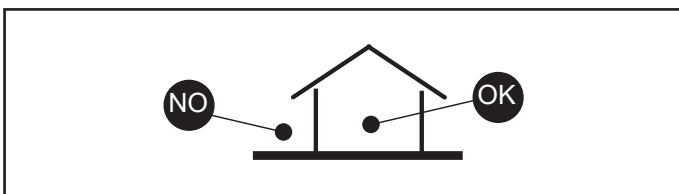

IT Per le posizioni di installazione, attenersi a quelle illustrate, eventualmente contattare la iGuzzini.

EN All installation positions must comply with those illustrated. In the event of any doubt, contact iGuzzini.

FR Pour les positions d'installation, se conformer aux positions illustrées ; contacter la société iGuzzini en cas de nécessité

DE Für die Einbaupositionen die Abbildungen beachten. Eventuell iGuzzini kontaktieren.

NL Houd u voor de installatieposities aan degene die zijn weergegeven. Neem eventueel contact op met iGuzzini

ES Respetar las posiciones de instalación ilustradas y, en caso de duda, contactar con iGuzzini

DA For installationspositioner skal man holde sig til de viste, og eventuelt kontakte iGuzzini

NO For installasjonsplasseringene henviser vi til illustrasjonene, eller ta eventuelt kontakt med iGuzzini

SV Följ de angivna positionerna för installationen. Kontakta vid behov iGuzzini

RU При выборе положения для монтажа следует обратиться к проиллюстрированным либо обратиться в компанию iGuzzini

ZH 安装位置请参考图示，必要时也可联系iGuzzini

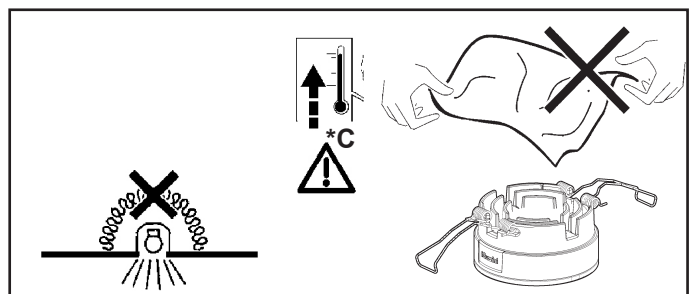
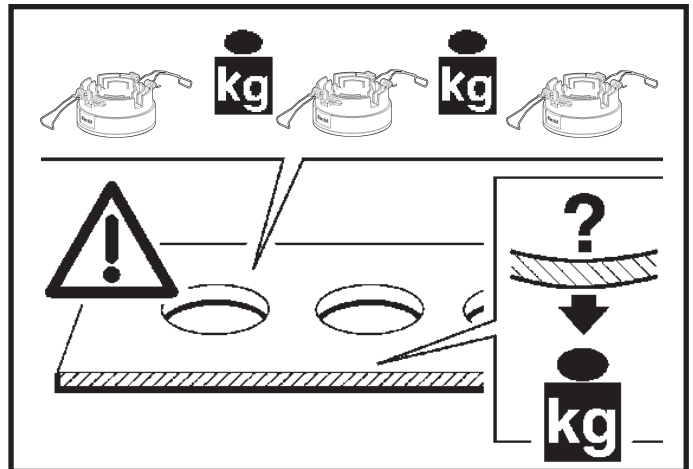

IT N.B.: Apparecchi non idonei ad essere coperti di materiale termicamente isolante

EN N.B.: Fixtures not suitable to be covered in thermally-insulating material.

FR N.B.: Appareils ne pouvant pas être couverts de matériau d'isolation thermique

DE N.B.: Geräte nicht geeignet, um mit wärmeisolierendem Material abgedeckt zu werden

NL N.B.: Deze apparaten zijn niet geschikt om te worden bedekt met thermisch isolerend materiaal

ES NOTA: Aparatos no aptos para ser cubiertos de material térmicamente aislante

DA N.B.: Armaturerne må ikke dækkes af varmeisolerende materiale.

NO N.B.: Apparatene passer ikke til å dekkes av termoiserende materialer.

SV OBS! Utrustningen får inte täckas över med värmeisolerande material

RU Внимание: Приборы непригодны для покрытия термоизоляционным материалом.

ZH 灯具不适宜用隔热材料加以覆盖。

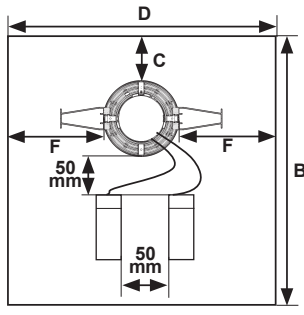
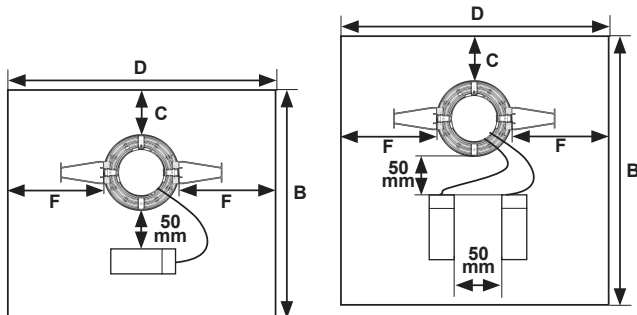
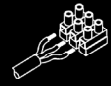

18X + QW41

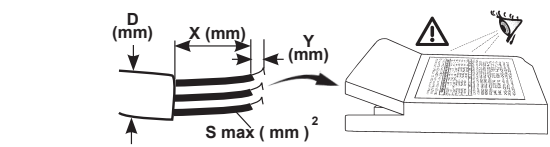
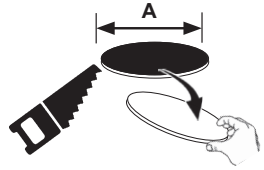
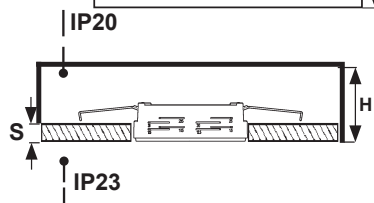

- IT Per il collegamento elettrico fare riferimento alla marcatura dell'alimentatore.
- EN Refer to the marking on the power unit for the electrical connection.
- FR Pour le raccordement électrique se reporter au marquage du ballast.
- DE Den Anschluss an das Stromnetz gemäß Kennzeichnung auf dem Vorschaltgerät ausführen.
- NL Voor de elektrische aansluiting wordt verwezen naar de markering op de stroomvoorziening.
- ES Para la conexión eléctrica hacer referencia a las informaciones marcadas en el alimentador.
- DA For elektrisk tilslutning, se strømforsyningens mærkning.
- NO For elektrisk tilkobling, se merking på strømforsyningenheten.
- SV För elanslutningen se till märkningen på nätdelen.
- RU Для электрического подключения смотреть маркировку на блоке питания.
- ZH 连接电线时请参考供电装置上的标记。

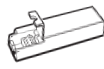
	S mm ²	Y mm	D mm	X mm
TCI PRO FLAT 30	0,75 - 1,5	8,5 - 9,5	1,5 - 10	30
OSRAM OT FIT LT2 S	0,75 - 1,5	6,5 - 7,5	3,55 - 9,65	
OSRAM OTI DALI 15	0,5 - 1,5	8,0 - 9,0	7 - 11	
OSRAM OTi DALI LT2	0,2 - 1,5	8,0 - 9,0	1,3 - 9	
TRIDONIC TALEX	0,2 - 1,5	8,5 - 9,5	2,2 - 9	
OSRAM OTi DALI LT2	0,2 - 1,5	8,0 - 9,0	7 - 11	
TCI PROFESSIONALI DALI	0,75 - 1,5	8,5 - 9,5	1,5 - 10	

ART.	+ ACCESSORIES	A mm +2 -0	C mm	F mm	D mm	B mm	H mm	S mm		
6x	/	84	50	80	244	301	100	12,5 ÷ 25	PA67	
12x	/	129	50	80	290	346			PA68	
18x	/	174	50	100	374	399			PA69	
12x	PB06 - PB13 PB14 - PB17 PB18 - PB19 PB20 - RL22 RL23 - RL24 RL25 - RL26 RL27	129	50	80	290	422	200	12,5 ÷ 25	PA68	
18x	PB07	174	50	100	374	474	200		200	PA69
	PB08 PB09					584	100			
	PB11 - PB12 PB10 - PC45					399				
18x	PB15 - PB16 PB21 - PB22 PB23 - PB24 PB25 - PB26 QW39-QW40 QW41-QW42 QX46 - R445 R446 - R447 RL28 - RL29 RL30 - RL31 RL32 - RL33 RL34	174	50	100	374	474	200	12,5 ÷ 25	PA69	

DALI

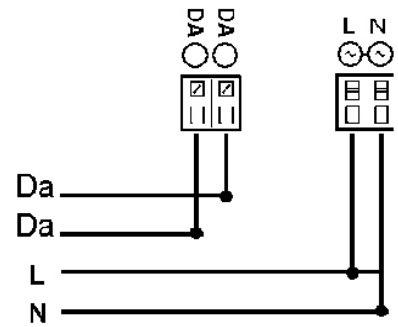

TOUCH DIM SWITCH DIM PUSH SWITCH

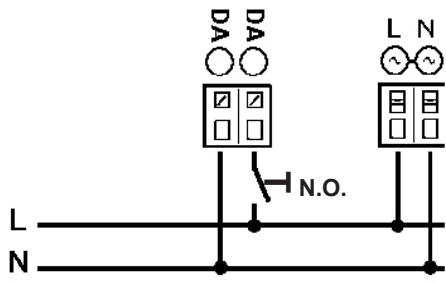

IT I dispositivi con cablaggio digitale possono essere dimmerati con dispositivi DALI o con pulsante normalmente aperto (N.O.) da collegare come da schema.

EN Devices with digital control gear may be dimmed using DALI devices or a normally-open button (N.O.) to be connected as shown in the diagram.

FR Les articles à câblage numérique peuvent fonctionner avec des variateurs à dispositifs DALI ou à bouton poussoir normalement ouvert (N.O.) à relier conformément au schéma.

DE Die Geräte mit digitaler Verkabelung können mit Hilfe von DALI-Vorrichtungen oder mit Hilfe eines gemäß Schaltplan anzuschließenden Schließers (N.O.) gedimmt werden.

NL De producten met digitale bekabeling kunnen worden gedimd met DALI systemen of met een N.O. (normally open) knop, die moet worden aangesloten volgens schema.

ES Los dispositivos con cableado digital pueden regularse con dispositivos DALI o con un interruptor de botón normalmente abierto (N.O.) que se conecta según ilustrado en el esquema.

DA Produkter med digital kabelføring kan dæmpes med DALI-anordninger eller med kontakten, som normalt er åben (N.O.) og som skal tilsluttes, som vist.

NO Produkter med digitalt kabler kan dimmes med DALI-anordninger eller med en normalt åpen (NO) trykkbryter som kobles som vist i koblingskjema.

SV Produkter med digital kabeldragning kan föras med dimmer. Detta kan göras med DALI-anordningarna eller med en normalt öppen kontakt (N.O.) som ska anslutas enligt schemat.

RU Интенсивность приборов с цифровой проводкой может регулироваться посредством устройств DALI или нормально разомкнутой кнопкой (Н.Р.), подсоединяемой согласно схеме.

ZH 带有数字控制装置的设备可以通过 DALI (数字化可寻址调光接口) 设备或者一个连接方式如图中所示的常开按钮 (N.O.) 进行亮度调节

IT Pilotare diversi prodotti DALI tramite pulsante (es: Touch-dim, Switch-dim, Push-dim, Direct-dim, etc.) potrebbe causare dei problemi di sincronizzazione tra gli stessi. È possibile ovviare a questo problema dotandosi di dispositivi aggiuntivi. Per maggiori informazioni vi invitiamo a contattarci direttamente.

EN Controlling different DALI products through buttons (e.g.: Touch-dim, Switch-dim, Push-dim, Direct-dim, etc.) may lead to product synchronisation problems. This problem can be overcome by using additional devices. For further information, please contact us directly.

FR Piloter plusieurs produits DALI par bouton (ex : Touch-dim, Switch-dim, Push-dim, Direct-dim, etc.) pourrait causer des problèmes de synchronisation entre eux. Ce problème peut être évité en s'équipant de dispositifs supplémentaires. Pour de plus amples renseignements, veuillez nous contacter directement.

DE Die Steuerung verschiedener DALI-Produkte mittels Taste (z.B.: Touch-dim, Switch-dim, Push-dim, Direct-dim etc.) kann eventuell zu Synchronisierungsproblemen zwischen diesen führen. Dieses Problem lässt sich durch den Einsatz von zusätzlichen Geräten beheben. Wenn Sie weitere Informationen wünschen, setzen Sie sich bitte direkt mit uns in Verbindung.

NL Het besturen van verschillende DALI producten m.b.v. dezelfde knop (bv.: Touch-dim, Switch-dim, Push-dim, Direct-dim, etc.) kan synchronisatieproblemen tussen de producten opleveren. Men kan dit probleem voorkomen door extra systemen aan te sluiten. Voor verdere informatie raden we u aan direct contact met ons op te nemen.

ES El mando de varios productos DALI por tecla (ej: Touch-dim, Switch-dim, Push-dim, Direct-dim, etc.) podría causar problemas de sincronización entre ellos. Es posible prevenir este problema utilizando dispositivos adicionales. Para más información, contacte directamente con nosotros.

DA Hvis DALI-produkterne styres ved hjælp af knapperne (fx. Touch-dim, Switch-dim, Push-dim, Direct-dim osv.), kan det skabe problemer med synkronisering af samme. Dette problem kan undgås, hvis man køber ekstra enheder. For yderligere oplysninger, kontakt os direkte.

NO Å styre ulike DALI-produkter ved hjelp av en trykknappbryter (f.eks. touch-dim, switch-dim, push-dim, direct-dim, osv.) vil kunne føre til problemer med synkroniseringen mellom dem. Dette problemet kan løses ved hjelp av noen tilleggsinnretninger. Ta gjerne kontakt med oss for mer informasjon om dette.

SV Styrning av olika DALI-produkter med knapp (t.ex.: Touch-dim, Switch-dim, Push-dim, Direct-dim o.s.v.) kan orsaka synkroniseringsproblem mellan dessa. Detta problem kan åtgärdas med tillägsanordningar. För mer information kan du kontakta oss direkt.

RU Управление различными продуктами DALI с помощью кнопки (напр.: Touch-dim, Switch-dim, Push-dim, Direct-dim и пр.) может вызвать проблемы синхронизации между ними. Эту проблему можно устранить путем задействования дополнительных устройств. За получением более подробной информации просим Вас связаться с нами непосредственно.

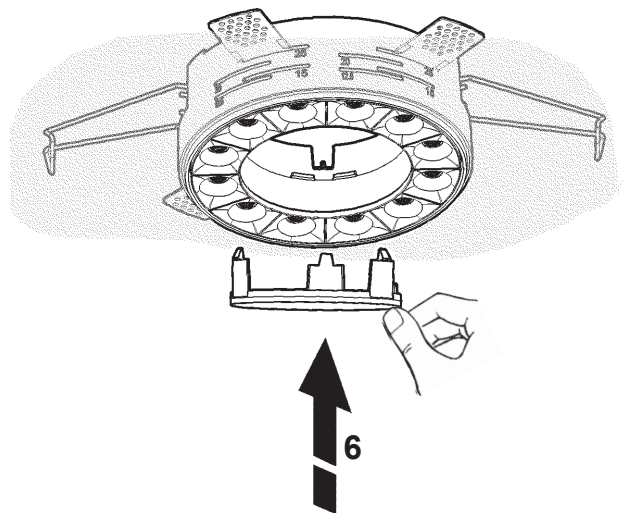
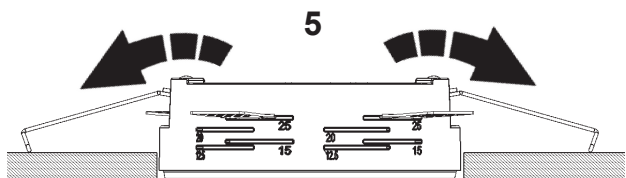

ZH 通过按钮控制不同的 DALI 产品 (例如: 触摸调光、切换调光、按压调光、直接调光等) 可能会导致产品的同步问题。该问题可通过使用其他额外的装置加以克服。如需了解更多信息, 请直接与我们联系。

	<p>CARICO DALI / DALI LOAD CHARGE DALI (COURANT MAXI ADMISSIBLE) DALI-LAST DALI VERMOGEN CARGA DALI DALI STRØMSTYRKE BELASTNING FOR "DALI" DALI-BELASTNING МАКС. ТОК СИСТЕМЫ DALI С РЕГУЛЯЦИЕЙ ИНТЕНСИВНОСТИ СВЕТА DALI 智能调光系统允许的最大电流</p>	<p>INDIRIZZI DALI DALI ADDRESSES ADRESSES DALI DALI-ADRESSEN DALI ADRESSEN DIRECCIONES DALI DALI ADDRESSER ADRESSER TIL "DALI" DALI-ADDRESSER ЛОГИЧЕСКИЕ АДРЕСА СИСТЕМЫ DALI DALI智能调光系统计算机指定控制参数</p>
ART.	1	1



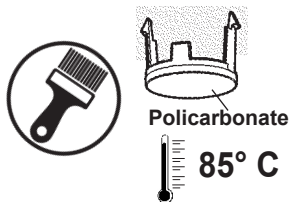



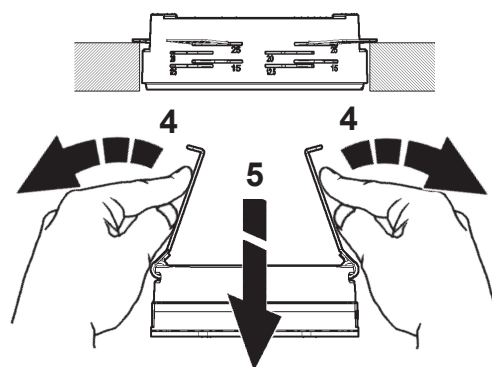
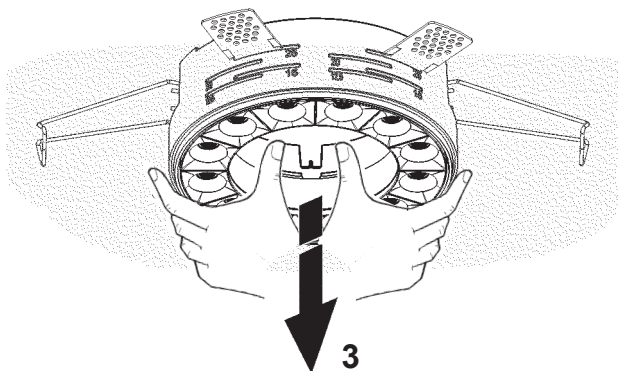
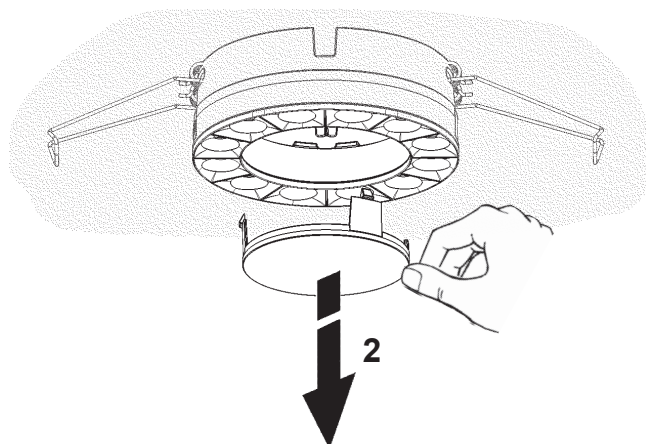
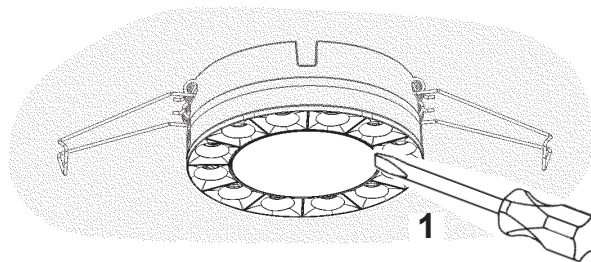
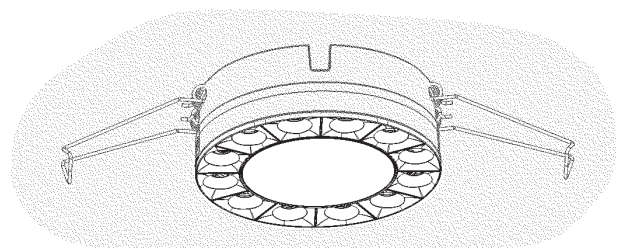
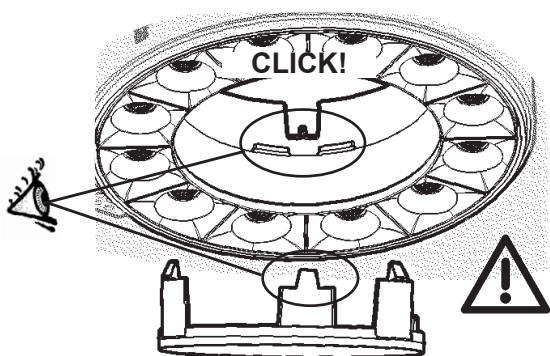

FOR PAINTING

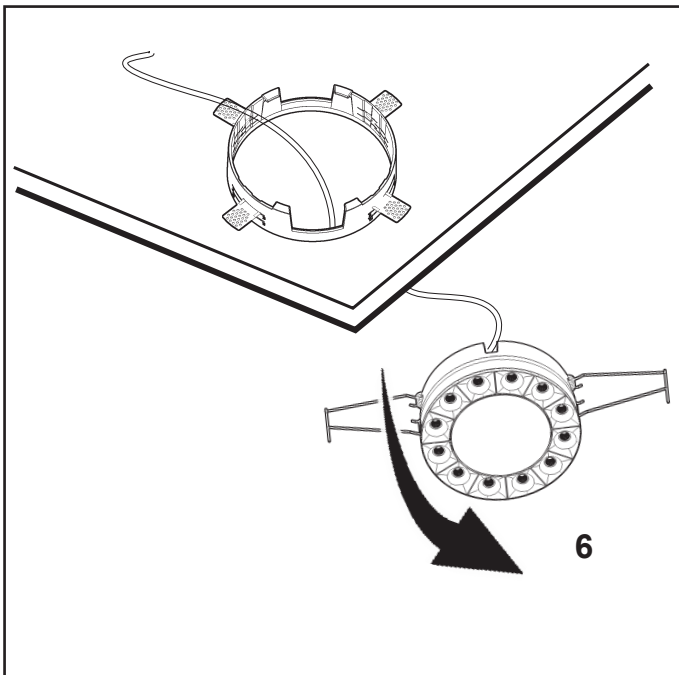

ART.	
	6x PA89
	12x PA90
	18x PA91





ART	ACCESSORIES	6 LED	12 LED	18 LED
PB06	MULTISENSOR BLUETOOTH 	X	✓	X
PB07		X	X	✓
PB08	INVERTER KIT 	X	X	✓
PB09		X	X	✓
PB10	SPEAKER 	X	X	✓
PB11	COVER SMOKE SENSOR 	X	X	✓
PB12	COVER VIDEO CAMERA	X	X	✓
PC45				
PB13	FRAMER KIT 	X	✓	X
PB14		X	✓	X
RL22		X	✓	X
RL23		X	✓	X
PB15		X	X	✓
PB16		X	X	✓
RL28		X	X	✓
RL29		X	X	✓
PB17	LASER KIT 	X	✓	X
PB18		X	✓	X
PB19		X	✓	X
PB20		X	✓	X
RL24		X	✓	X
RL25		X	✓	X
RL26		X	✓	X
RL27		X	✓	X
RL30		X	X	✓
RL31		X	X	✓
RL32		X	X	✓
RL33		X	X	✓
PB21		X	X	✓
PB22		X	X	✓
PB23		X	X	✓
PB24		X	X	✓
PB25		X	X	✓
PB26		X	X	✓
QW39	EASY KIT 	X	X	✓
QW40		X	X	✓
QW41		X	X	✓
QW42		X	X	✓
RL34		X	X	✓
QX46		X	X	✓
R445		X	X	✓
R446		X	X	✓
R447		X	X	✓

IT Per l'installazione degli accessori fare riferimento al foglio istruzioni relativo.
 EN For the installation of the accessories, please refer to the relevant instruction sheet.
 FR Pour l'installation des accessoires, se reporter à la feuille d'instructions correspondante.
 DE Zum Anbringen des Zubehörs halten Sie sich bitte an die jeweils entsprechende Bedienungsanweisung.
 NL Voor het installeren van de accessoires moet u zich wenden tot het bijbehorende instructiebladje.
 ES Para informaciones sobre la instalación de los accesorios ver la hoja de instrucciones.
 DA Se den pågældende installationsvejledning for installation af tilbehør.
 NO For installasjon av tilbehøret, vennligst se tilhørende instruksjonsark.
 SV För installationen av tillbehören, se respektive instruktionsblad.
 RU Порядок монтажа аксессуаров смотрите в соответствующих инструкциях.
 ZH 安装附件时，请参阅相关说明表。

SOSTITUZIONE DEL LED
 REPLACING THE LED
 REMPLACEMENT DE LA LED
 AUSTAUSCHEN DER LED
 VERVANGEN VAN DE LED
 REEMPLAZO DEL LED
 UDSKIFTNING AF LYSDIODE
 BYTTE AV LYSDIOD
 UTSKIFTNING AV DEN LYSEMITTERENDE DIODEN
 Замена светодиода
 发光二极管替换

IT N.B.: Per la sostituzione del LED contattare l'azienda iGuzzini.
 EN N.B.: For information on LED replacement please contact iGuzzini.
 FR N.B.: Pour procéder au remplacement de la LED, adressez-vous à la société iGuzzini.
 DE N.B.: Bezüglich des Austausches der LED kontaktieren Sie bitte die Firma iGuzzini.
 NL N.B.: Voor het vervangen van de LED neemt u contact op met het bedrijf iGuzzini.
 ES NOTA: Para sustituir el LED llame a la empresa iGuzzini.
 DA N.B.: For udskiftning af lysdioden, skal man kontakte iGuzzini.
 NO N.B.: For informasjon om skifte av LED, vennligst ta kontakt med iGuzzini.
 SV OBS! För byte av lysdioden, kontakta företaget iGuzzini.
 RU ПРИМЕЧАНИЕ: Для замены СИДов обращайтесь в компанию iGuzzini.
 ZH 注意：如需LED更换的信息，请联系iGuzzini。

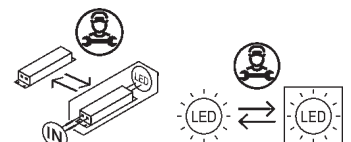

Headquarters iGuzzini illuminazione spa
 via Mariano Guzzini, 37 - 62019 Recanati Italy

BLADE "R" MINIMAL

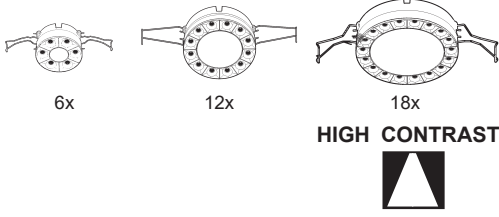

تحذير:

AR لا يمكن ضمان سلامة هذا الجهاز إلا إذا التزمت بهذه التعليمات، يجب حفظها في مكان آمن.

IT ATTENZIONE:

LA SICUREZZA DELL'APPARECCHIO E' GARANTITA SOLO CON L'USO APPROPRIATO DELLE SEGUENTI ISTRUZIONI; PERTANTO E' NECESSARIO CONSERVARLE.

EN WARNING:

THE SAFETY OF THIS FIXTURE IS GUARANTEED ONLY IF YOU COMPLY WITH THESE INSTRUCTIONS; REMEMBER TO CONSERVE IN A SAFE PLACE.

ES ATENCION:

LA SEGURIDAD DEL APARATO SE GARANTIZA SOLO CUMPLIENDO CUIDADOSAMENTE LAS SIGUIENTES INSTRUCCIONES; POR ELLO, ES NECESARIO CONSERVARLAS.

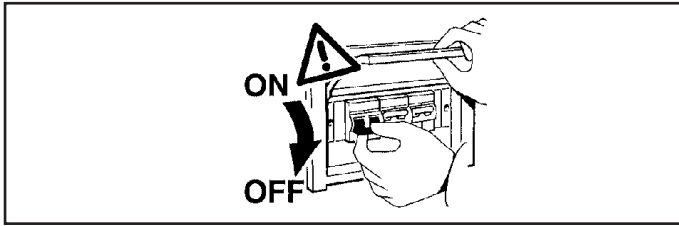

AR ملاحظة: ملاحظة: أثناء تركيب نظام بحرص بالنظم السائدة المتعلفة بالشبكة الكهربائية.

IT N.B.: DURANTE L'INSTALLAZIONE DEL SISTEMA RISPETTARE SCRUPolosAMENTE LE NORME IMPIANTISTICHE VIGENTI.

EN N.B.: WHEN INSTALLING THE SYSTEM STRICTLY COMPLY WITH ALL REGULATIONS ON INSTALLATION IN FORCE.

ES N.B.: DURANTE LA INSTALACIÓN DEL SISTEMA RESPETAR ESCRUPolosAMENTE LAS NORMAS DE INSTALACIÓN VIGENTES.

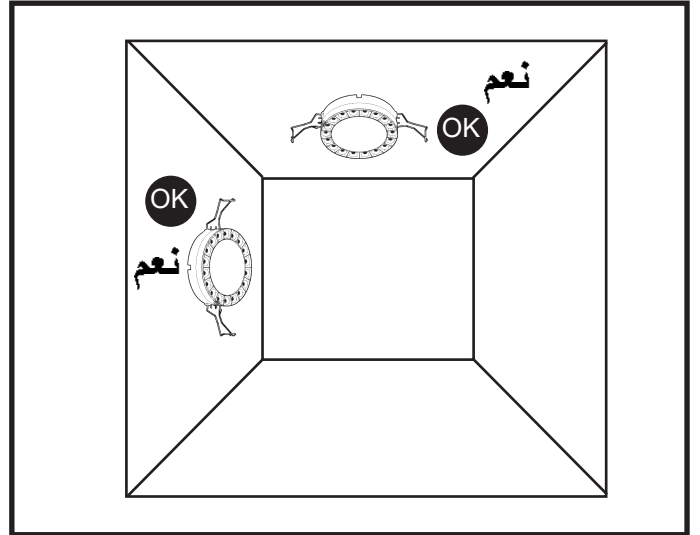
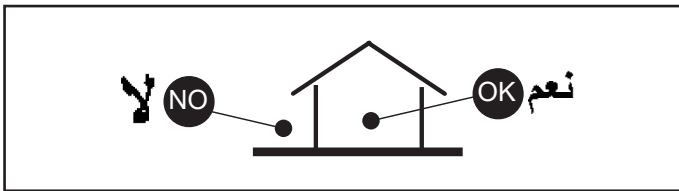

AR في ما يتعلق بأوضاع التركيب، التزم بما هو موضح ومحدد، إذا دعت الضرورة اتصل بـ iGuzzini.

IT Per le posizioni di installazione, attenersi a quelle illustrate, eventualmente contattare la iGuzzini.

EN All installation positions must comply with those illustrated. In the event of any doubt, contact iGuzzini.

ES Respetar las posiciones de instalación ilustradas y, en caso de duda, contactar con iGuzzini.

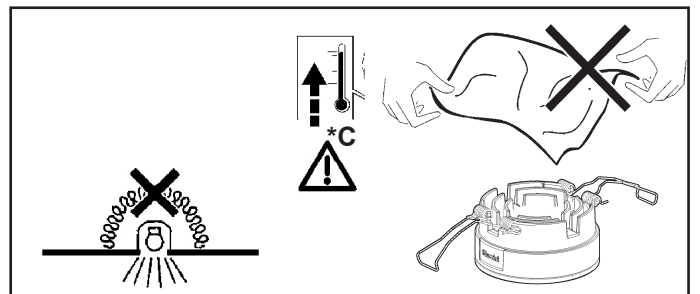
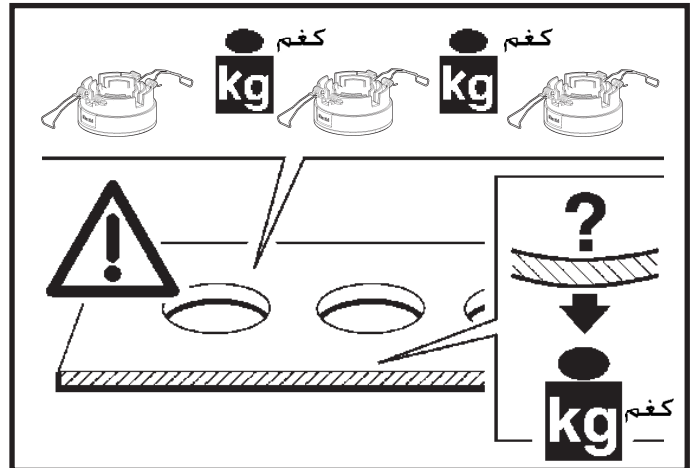

AR ملاحظة: أجهزة غير قابلة للتغطية مواد عازلة حرارياً.

IT N.B.: Apparecchi non idonei ad essere coperti di materiale termicamente isolante

EN N.B.: Fixtures not suitable to be covered in thermally-insulating material.

ES OBS! Utrustningen får inte täckas över med värmeisolerande material

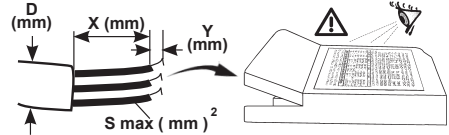

AR لتوصيل بانكهر باء قم بالرجوع الى العلامة المتواجدة على وحدة التغذية
 IT Per il collegamento elettrico fare riferimento alla marcatura dell'alimentatore.
 EN Refer to the marking on the power unit for the electrical connection.
 ES Para la conexión eléctrica hacer referencia a las informaciones marcadas en el alimentador.

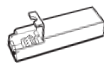
	S mm ²	Y mm	D mm	X mm
TCI PRO FLAT 30	0,75 - 1,5	8,5 - 9,5	1,5 - 10	30
OSRAM OT FIT LT2 S	0,75 - 1,5	6,5 - 7,5	3,55 - 9,65	
OSRAM OTi DALI 15	0,5 - 1,5	8,0 - 9,0	7 - 11	
OSRAM OTi DALI LT2	0,2 - 1,5	8,0 - 9,0	1,3 - 9	
TRIDONIC TALEX	0,2 - 1,5	8,5 - 9,5	2,2 - 9	
OSRAM OTi DALI LT2	0,2 - 1,5	8,0 - 9,0	7 - 11	
TCI PROFESSIONALI DALI	0,75 - 1,5	8,5 - 9,5	1,5 - 10	

DALI

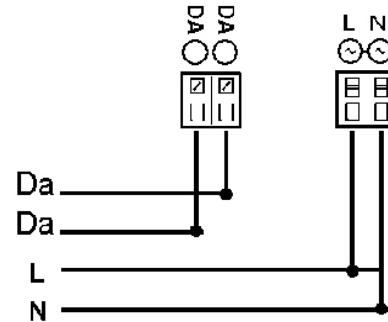

TOUCH DIM SWITCH DIM PUSH SWITCH

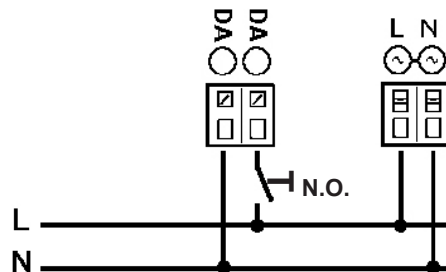

AR يمكن أن يتم تخفيض إضاءة الأجهزة ذات الكابلات الرقمية؛ وذلك عن طريق استخدام أجهزة الإمداد بالطاقة الكهربائية "دالي" (DALI)، أو عن طريق استخدام زر يكون مفتوحاً في وضعه الطبيعي (N.O.)؛ حيث يتم التوصيل كما هو مبين في المخطط.

IT I dispositivi con cablaggio digitale possono essere dimmerati con dispositivi DALI o con pulsante normalmente aperto (N.O.) da collegare come da schema.

EN Devices with digital control gear may be dimmed using DALI devices or a normally-open button (N.O.) to be connected as shown in the diagram.

ES Los dispositivos con cableado digital pueden regularse con dispositivos DALI o con un interruptor de botón normalmente abierto (N.O.) que se conecta según ilustrado en el esquema.

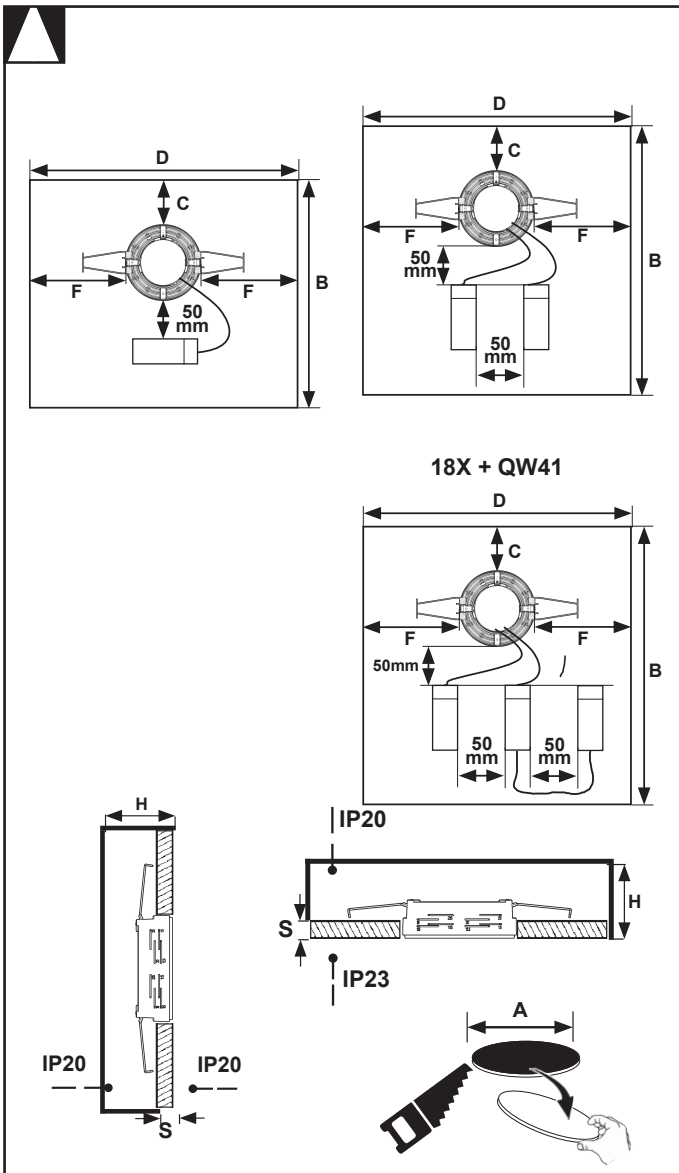

18X + QW41

الصف ART.	+ ACCESSORIES	A mm +2 -0	C mm	F mm	D mm ملم	B mm	H mm	S mm	 ADAPTER
6x	/	84	50	80	244	301	100	12,5 ÷ 25	PA67
12x	/	129	50	80	290	346			PA68
18x	/	174	50	100	374	399			PA69
12x	PB06 - PB13 PB14 - PB17 PB18 - PB19 PB20 - RL22 RL23 - RL24 RL25 - RL26 RL27	129	50	80	290	422	200	12,5 ÷ 25	PA68
18x	PB07	174	50	100	374	474	200		
	PB08 PB09					584	100		
	PB11 - PB12 PB10 - PC45					399	200		
18x	PB15 - PB16 PB21 - PB22 PB23 - PB24 PB25 - PB26 QW39-QW40 QW41-QW42 QX46 - R445 R446 - R447 RL28 - RL29 RL30 - RL31 RL32 - RL33 RL34	174	50	100	374	474	200	12,5 ÷ 25	PA69

AR يمكن ان يتسبب التحكم في منتجات "التي" المختلفة عن طريق الازرار ، (مثل الازرار : "تفتش - ديم"، "موينش - ديم"، "بوش - ديم"، "دايركت - ديم"، "التي") ، في حدوث مشاكل تتعلق بعملية التزامن بين هذه الازرار. وإن كان من الممكن تجنب مثل هذه المشاكل، وذلك عن طريق تزويد بعض الاجهزة الإضافية: ندعوكم للاتصال بنا بالشركة، وذلك للحصول على أكبر قدر من المعلومات.

IT Pilotare diversi prodotti DALI tramite pulsante (es: Touch-dim, Switch-dim, Push-dim, Direct-dim, etc.) potrebbe causare dei problemi di sincronizzazione tra gli stessi. È possibile ovviare a questo problema dotandosi di dispositivi aggiuntivi. Per maggiori informazioni vi invitiamo a contattarci direttamente.

EN Controlling different DALI products through buttons (e.g.: Touch-dim, Switch-dim, Push-dim, Direct-dim, etc.) may lead to product synchronisation problems. This problem can be overcome by using additional devices. For further information, please contact us directly.

ES El mando de varios productos DALI por tecla (ej: Touch-dim, Switch-dim, Push-dim, Direct-dim, etc.) podría causar problemas de sincronización entre ellos. Es posible prevenir este problema utilizando dispositivos adicionales. Para más información, contacte directamente con nosotros.

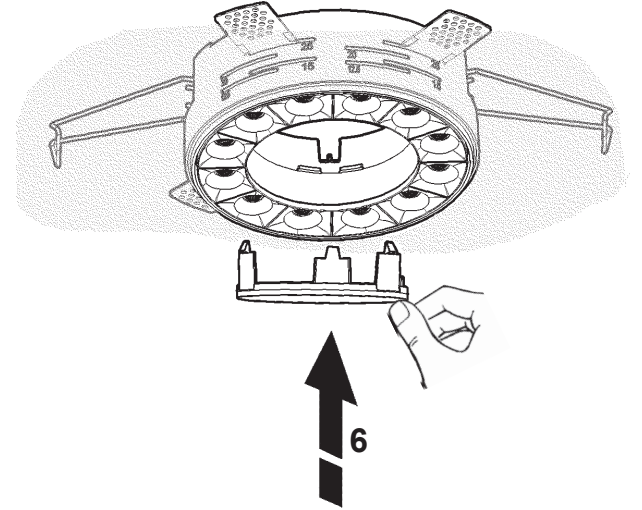
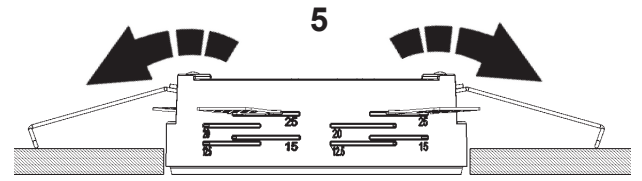

FOR PAINTING

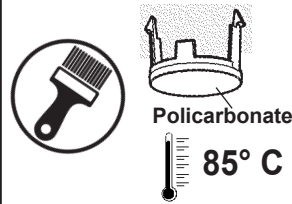

ART.

6x	PA89
12x	PA90
18x	PA91

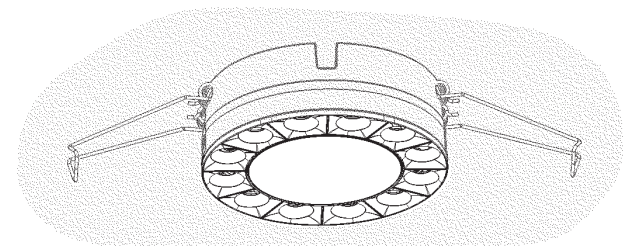
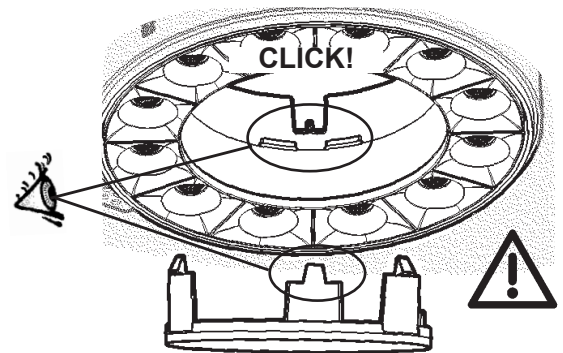

DALI حمل / DALI شحنة
CARICO DALI / DALI LOAD
CHARGE DALI
CARGA DALI

عناوين DALI
INDIRIZZI DALI
DALI ADDRESSES
DIRECCIONES DALI

ART.





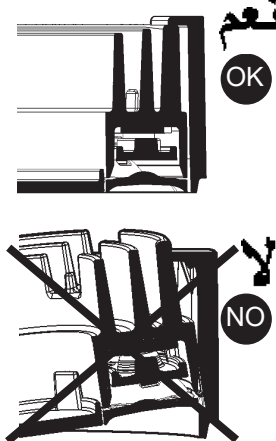
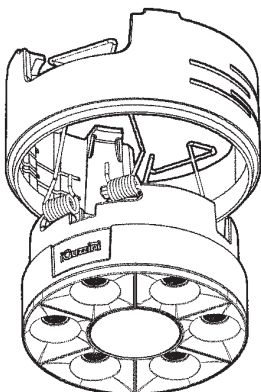
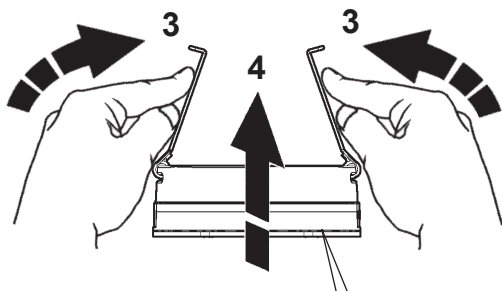
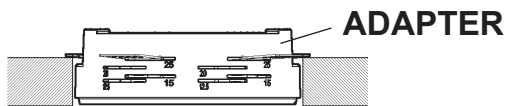
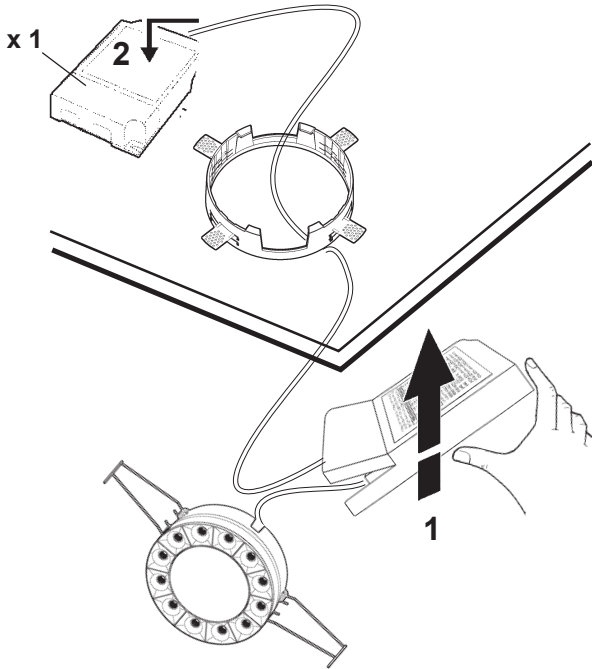

1

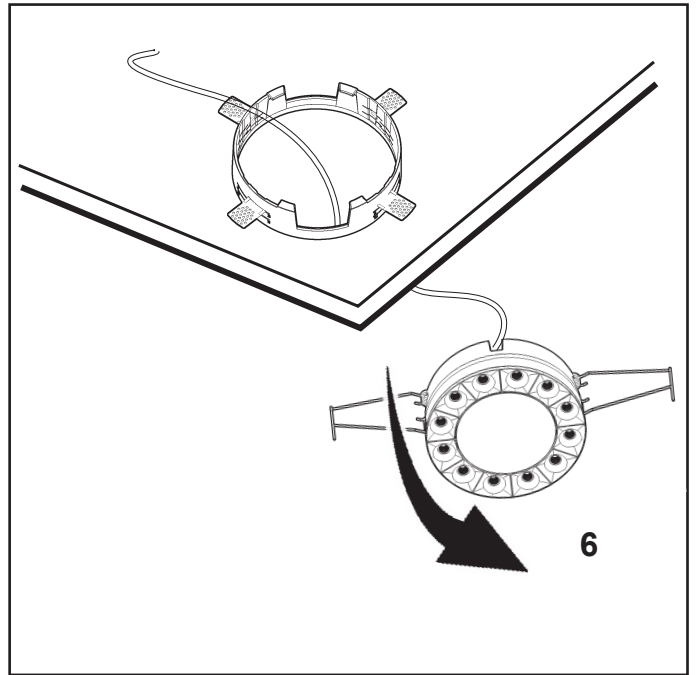
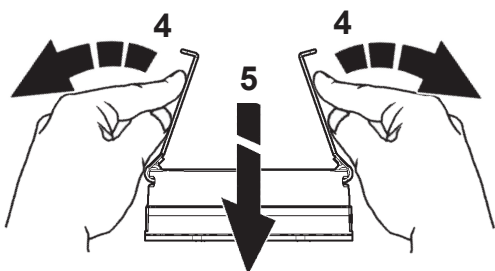
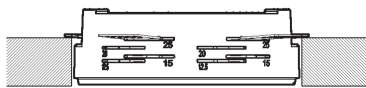
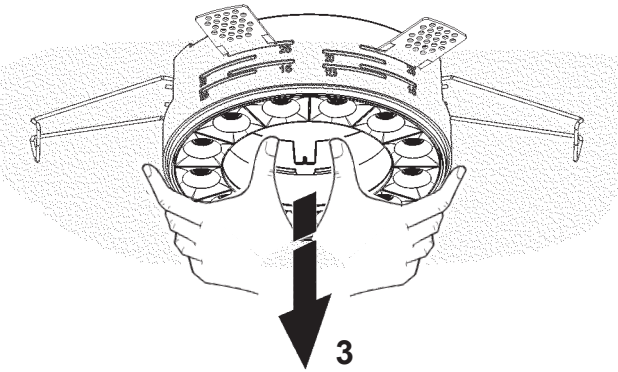
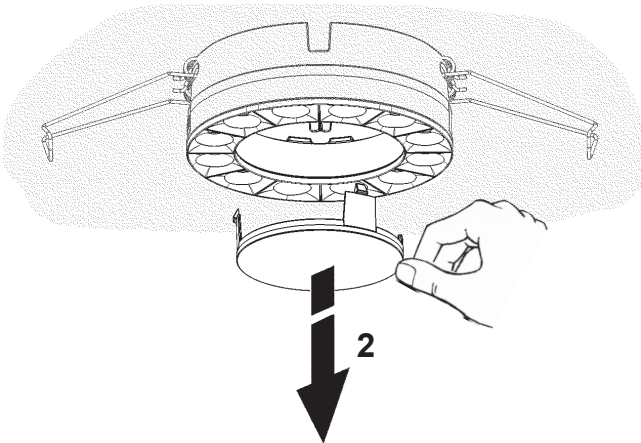
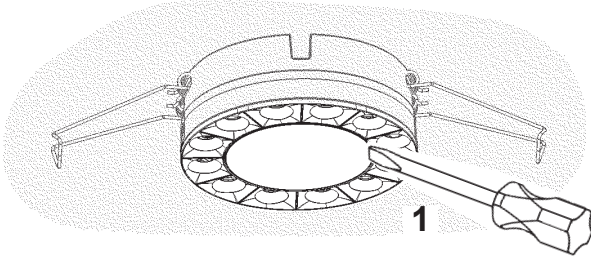
1



MAINTENANCE



ART	ACCESSORIES	6 LED	12 LED	18 LED
PB06	MULTISENSOR BLUETOOTH 	X	✓	X
PB07		X	X	✓
PB08	INVERTER KIT 	X	X	✓
PB09		X	X	✓
PB10	SPEAKER 	X	X	✓
PB11	COVER SMOKE SENSOR 	X	X	✓
PB12	COVER VIDEO CAMERA	X	X	✓
PC45				
PB13	FRAMER KIT 	X	✓	X
PB14		X	✓	X
RL22		X	✓	X
RL23		X	✓	X
PB15		X	X	✓
PB16		X	X	✓
RL28		X	X	✓
RL29		X	X	✓
PB17	LASER KIT 	X	✓	X
PB18		X	✓	X
PB19		X	✓	X
PB20		X	✓	X
RL24		X	✓	X
RL25		X	✓	X
RL26		X	✓	X
RL27		X	✓	X
RL30		X	X	✓
RL31		X	X	✓
RL32		X	X	✓
RL33		X	X	✓
PB21		X	X	✓
PB22		X	X	✓
PB23		X	X	✓
PB24		X	X	✓
PB25		X	X	✓
PB26		X	X	✓
QW39	EASY KIT	X	X	✓
QW40		X	X	✓
QW41		X	X	✓
QW42		X	X	✓
RL34		X	X	✓
QX46		X	X	✓
R445		X	X	✓
R446		X	X	✓
R447		X	X	✓

AR تركيب الملحقات، يجب مراجعة ورقة التعليمات الخاصة بها.

IT Per l'installazione degli accessori fare riferimento al foglio istruzioni relativo.

EN For the installation of the accessories, please refer to the relevant instruction sheet.

ES Para informaciones sobre la instalación de los accesorios ver la hoja de instrucciones.

LED استبدال الضوء

SOSTITUZIONE DEL LED
REPLACING THE LED
REEMPLAZO DEL LED

AR . iGuzzini **تنبيه: لاستبدال الضوء LED اتصل بشركة**

IT **N.B.:** Per la sostituzione del LED contattare l'azienda iGuzzini.

EN **N.B.:** For information on LED replacement please contact iGuzzini.

ES **NOTA:** Para sustituir el LED llame a la empresa iGuzzini.

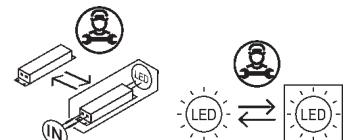

- I Istruzioni per le operazioni di servizio per l'apparecchio di illuminazione**
GB Instructions on luminaire service operations
F Instructions pour les opérations de service du luminaire
D Wartungsanleitung für die Leuchte
NL Instructies voor de onderhoudsoperaties op de verlichtingsarmatuur
E Instrucciones para las operaciones de servicio del aparato de alumbrado
DK Anvisninger i serviceindgreb på belysningsarmatur
N Anvisninger for betjening av lysapparatet
S Instruktioner för användning av belysningsanordningen
RUS Инструкции по эксплуатации осветительного прибора
CN 照明装置检修操作说明

Sostituire la lampada parzialmente esausta
 Replace the partly exhausted lamp
 Remplacer la lampe partiellement épuisée
 Die teilweise erschöpfte Lampe austauschen
 Vervang de gedeeltelijk lege lamp
 Sustituir la lámpara parzialmente agotada
 Udskift den delvist udtjente pære
 Skifte ut den delvis utbrænte lyspæren
 Byt ut den delvis förbrukade lampan
 Замена частично отработанной лампочки
 更换部分老化的灯泡

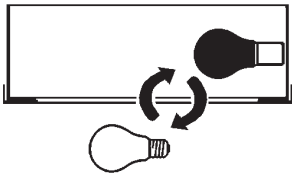

Spegnimento
 Switch it off
 Extinction
 Ausschaltung
 Uitschakeling
 Apagado
 Slukning
 Slukking
 Släckning
 Выключение
 关灯

Interrompere l'alimentazione dell'apparecchio
 Cut the power supply to the luminaire
 Couper l'alimentation du luminaire
 Stromversorgung der Leuchte unterbrechen
 Onderbreek de voeding van het apparaat
 Interrumpir la alimentación del aparato
 Afbryd armaturets strømforsyning
 Avbryte strømtilførselen til apparatet
 Koppla från anordningens strömförsörjning
 Отключить электропитание прибора
 中断装置供电



Aprire l'apparecchio
 Open the fixture
 Ouvrir le luminaire
 Das Gerät öffnen
 Open het apparaat
 Abrir el aparato
 Åbn armaturet
 Åpne apparatet
 Öppna anordningen
 Раскрыть прибор
 打开装置

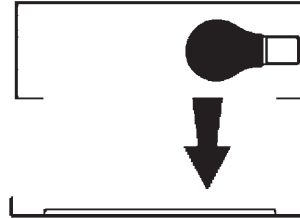

Rimuovere la lampada esausta
 Remove the exhausted lamp
 Retirer la lampe épuisée
 Die alte Lampe entnehmen
 Verwijder de lege lamp
 Quitar la lámpara agotada
 Tag den udtjente pære ud
 Fjerne den utbrænte lyspæren
 Ta bort den förbrukade lampan
 Вынуть старую лампочку
 取出老化的灯泡

Portarla in un centro di riciclaggio
 Carry it to a recycling centre
 La porter dans une déchetterie pour son recyclage
 Ordnungsgemäß entsorgen
 Breng de lamp naar een recyclingcentrum
 Llevarla a un centro de reciclaje
 Aflever den på en genbrugsstation
 Lever den til en miljøstasjon
 Lämna in den till en återvinningsanläggning
 Сдать ее в пункт приема утильсырья
 将其送往回收中心



Inserire la nuova lampada
 Introduce the new lamp
 Installer la lampe neuve
 Die neue Lampe einsetzen
 Doe de nieuwe lamp op zijn plek
 Montar la nueva lámpara
 Sæt den nye pære i
 Sette i den nye pæren
 Sätt i den nya lampan
 Вставить новую лампочку
 装入新灯泡

Inserire la nuova lampada nel portalampana
 Fit the new lamp into the socket
 Installer la nouvelle lampe dans le support de lampe
 Die neue Lampe in den Sockel einsetzen
 Doe de nieuwe lamp in de lamphouder
 Montar la nueva lámpara en el portalampana
 Sæt den nye pære i fatningen
 Sette den nye pæren inn i lampeholderen
 Sätt i den nya lampan i lamphållaren
 Вставить новую лампочку в патрон
 将新灯泡插入灯泡架中



Riposizionare ottica
 Re-place the optic
 Remettre l'optique à sa place
 Die Optik wieder einsetzen
 Doe de optiek weer op zijn plaats
 Volver a montar la óptica
 Sæt den optiske enhed på plads
 Innstille linsen
 Flytta om optiken
 Отрегулировать линзы
 重新定位光头



Effettuare prova di funzionamento
 Perform operative test
 Procéder à un essai de fonctionnement
 Eine Funktionsprüfung durchführen
 Controleer de correcte werking
 Hacer una prueba de funcionamiento
 Afprøv funktionen
 Prové om den fungerer
 Utför funktionstest
 Выполнить проверку исправности работы
 执行功能测试



- I Istruzioni per la pulizia dell'apparecchio di illuminazione
 GB Instructions on luminaire cleaning operations
 F Instructions pour le nettoyage du luminaire
 D Anweisungen zur Reinigung der Leuchte
 NL Instructies voor de reiniging van de verlichtingsarmatuur
 E Instrucciones para limpiar el aparato de alumbrado
 DK Anvisninger i rengøring af belysningsarmaturet
 N Anvisninger for rengjøring av lysapparatet
 S Instruktioner för rengöring av belysningsanordningen
 RUS Инструкции по чистке осветительного прибора
 CN 照明装置清洁说明

Pulire l'apparecchio
 Clean the fixture
 Nettoyer le luminaire
 Das Gerät reinigen
 Reinig het apparaat
 Limpiar el aparato
 Rengør armaturet
 Rengjøre apparatet
 Rengör anordningen
 Чистка прибора
 清洁装置



Spegnimento
 Switch it off
 Extinction
 Ausschaltung
 Uitschakeling
 Apagado
 Slukning
 Slukking
 Släckning
 Выключение
 关灯

Interrompere l'alimentazione dell'apparecchio
 Cut the power supply to the luminaire
 Couper l'alimentation du luminaire
 Stromversorgung der Leuchte unterbrechen
 Onderbreek de voeding van het apparaat
 Interrumpir la alimentación del aparato
 Afbryd armaturets strømforsyning
 Avbryt strømtilførselen til apparatet
 Koppla från anordningens strömförsörjning
 Отключить электропитание прибора
 中断装置供电



Spolverare l'ottica esterna
 Remove dust from the external optic
 Dépoussiérer l'optique extérieure
 Die externe Optik abstauben
 Stof de externe optiek af
 Quitar el polvo de la óptica exterior
 Tør støvet af den udvendige optiske enhed
 Fjerne støv fra den eksterne lysenheden
 Damma av den yttre optiken
 Вытереть пыль с внешней стороны линз
 为外侧镜头掸尘



Lavare l'ottica esterna
 Wash the external optic
 Laver l'optique extérieure
 Die externe Optik waschen
 Was de externe optiek
 Lavar la óptica exterior
 Vask den udvendige optiske enhed
 Vaske den eksterne lysenheden
 Rengör den yttre optiken
 Вымыть линзы с внешней стороны
 清洁外镜头



Rimuovere l'ottica
 Remove the optic
 Retirer l'optique
 Die Optik abnehmen
 Verwijder de optiek
 Quitar la óptica
 Tag den optiske enhed af
 Fjerne lysenheden
 Ta bort optiken
 Снять линзы
 取下镜头



Pulire la parte interna dell'apparecchio di illuminazione
 Clean the inside of the fixture
 Nettoyer l'intérieur du luminaire
 Die Innenseite der Leuchte reinigen
 Reinig de binnenzijde van de verlichtingsarmatuur
 Limpiar el interior del aparato de alumbrado
 Rengør belysningsarmaturets indvendige dele
 Rengjøre lysapparatet innvendig
 Rengör belysningsanordningen invändigt
 Протереть осветительный прибор изнутри
 清洁照明装置内部



Riposizionare ottica
 Re-place the optic
 Remettre l'optique à sa place
 Die Optik wieder einsetzen
 Doe de optiek weer op zijn plaats
 Volver a montar la óptica
 Sæt den optiske enhed på plads
 Innstille linsen
 Flytta om optiken
 Отрегулировать линзы
 重新定位镜头

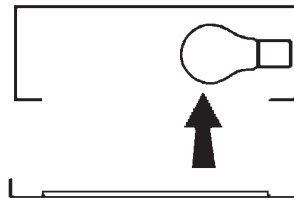

Effettuare prova di funzionamento
 Perform operative test
 Procéder à un essai de fonctionnement
 Eine Funktionsprüfung durchführen
 Controleer de correcte werking
 Hacer una prueba de funcionamiento
 Afprøv funktionen
 Prøve om den fungerer
 Utför funktionstest
 Выполнить проверку исправности работы
 执行功能测试



- I Istruzioni per il fine vita e lo smaltimento dei componenti**
GB Instructions on end-of-life and component disposal
F Instructions pour la gestion des composants en fin de vie et leur mise au rebut
D Anweisungen zur Entsorgung der Leuchtenkomponenten
NL Instructies voor het verwijderen van de armatuur en het recyclen van de onderdelen
E Instrucciones para el final de vida y la eliminación los componentes
DK Anvisninger i udtjent armatur og bortskaffelse af komponenter
N Anvisninger for endt levetid og avfallsbehandling av delene
S Instruktionser vid bortskaffning och kassering av komponenter
RUS Инструкции по утилизации прибора и его комплектующих по окончании его срока службы
CN 寿命期结束与零件废弃处置说明

Spegnimento
Switch it off
Extinction
Ausschaltung
Uitschakeling
Apagado
Slukning
Slukking
Släckning
Выключение
关灯

Interrompere l'alimentazione dell'apparecchio
Cut the power supply to the luminaire
Couper l'alimentation du luminaire
Stromversorgung der Leuchte unterbrechen
Onderbreek de voeding van het apparaat
Interrompirla alimentación del aparato
Afbryd armaturets strømforsyning
Avbryt strømtilførselen til apparatet
Koppla från anordningens strömförsörjning
Отключить электропитание прибора
中断装置供电



Rimuovere la/e lampada/e per la dismissione
Remove the lamp(s) for decommissioning
Retirer la(les) lampe(s) pour sa(leur) mise au rebut
Die Lampe/n ordnungsgemäß entsorgen
Verwijder de lamp(en) voor het recyclen
Quitar la(s) lámpara(s) para el desecho
Tag pæren/pærerne ud til bortskaffelse
Fjerne lampen/-e som skal kastes
Ta bort lampan/-orna för bortskaffningen
Вынуть лампочку/и для утилизации прибора
取出需要丢弃的灯泡



Rimuovere la batteria per la dismissione
Remove the battery for decommissioning
Retirer la batterie pour sa mise au rebut
Die Batterie ordnungsgemäß entsorgen
Verwijder de batterij voor het recyclen
Quitar la batería para el desecho
Tag batteriet ud til bortskaffelse
Fjerne batteriet som skal kastes
Ta bort batteriet för bortskaffningen
Вынуть батарейку для утилизации прибора
取出需要丢弃的电池



Rimuovere l'apparecchio per la dismissione
Remove the fixture for decommissioning
Enlever le luminaire pour sa mise au rebut
Das Gerät ordnungsgemäß entsorgen
Verwijder het apparaat voor het recyclen
Quitar el aparato para el desecho
Tag armaturet ud til bortskaffelse
Fjerne apparatet som skal kastes
Ta bort anordningen för bortskaffningen
Снять прибор для утилизации
取出需要丢弃的装置



Inviare i materiali ad un centro di raccolta
RAEE
Send the materials to a WEEE collection
centre
Envoyer les matériaux dans une déchetterie
DEEE
Die Materialien in einem WEEE-Zentrum
entsorgen
Zend de materialen naar een recyclingscentrum
voor de AEEA
Enviar los materiales a un centro de recogida
RAEE
Afløver materialerne på et indsamlingscenter
for elektronisk udstyr
Sende materialene til en miljøstasjon for
resirkulering av EE-avfall
Skicka materialet till en RAEE uppsamlingscentral
Сдать материалы в пункт приема утильсырья
将材料送往电气和电子垃圾回收中心

