

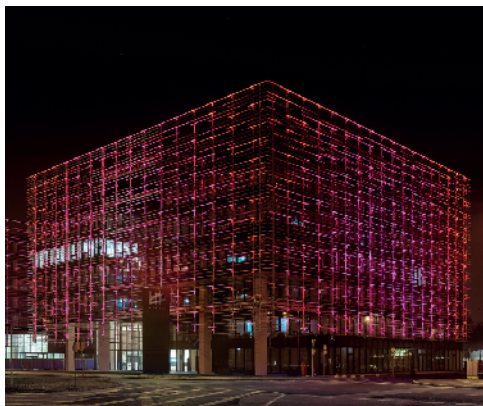

Surface mounted luminaire that emits a light blade without any unwanted dispersion. Design by Dean Skira.

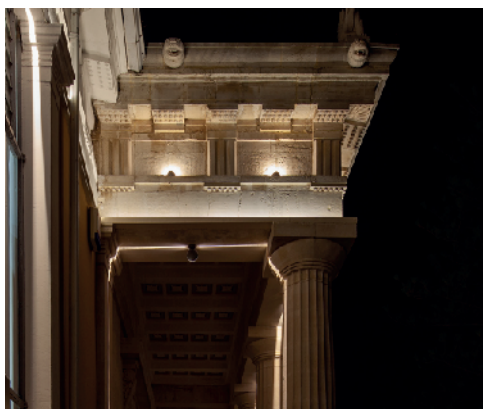

<b>Luminaire characteristic:</b>	Power input: 5.7W to 9.1W (source wattage) Lumens: 31lm to 172lm (for 3000K, 80CRI) Luminaire efficacy: Up to 19lm/W
<b>Source:</b>	White LED (LM-80), 3000K: 80CRI,
<b>Lumen maintenance:</b>	80% of initial lumens at 50 000 hours (L80) (LM-79).
<b>Optic:</b>	360° blade effect and light blade.
<b>Material:</b>	Body: Die-cast aluminum Diffuser: PMMA lens Hardware: Stainless steel screws
<b>Mounting:</b>	Wall or ceiling mounted, installs on standard 4" octagonal junction box. Floor mounting in dry location only (interior).
<b>Electrical:</b>	High efficiency dimmable remote LED driver, rated at 50 000 hours. See remote option on page 3.
<b>Finish:</b>	White (RAL9016), black, rust brown or gray (RAL9007) painted finish with a high level of weather and UV resistance. The semi-gloss finish coating is electrostatically applied, durable acrylic enamel baked at high temperatures for superior color retentive finish.
<b>Operating temperature:</b>	BO From -30°C to 50°C (-22°F to 122°F) HO From -30°C to 35°C (-22°F to 95°F)
<b>Weight:</b>	1.1lb (0.5kg)
<b>Warranty:</b>	5 year limited warranty.
<b>Ratings:</b>	IP66, IK07
<b>Certification:</b>	cULus listed for wet location.



**ORDERING INFO**



PRODUCT CODE

--	--	--	--	--	--	--	--

MODEL	SIZE	OUTPUT	MOUNTING	LED	OPTIC	VOLTAGE	FINISH
-------	------	--------	----------	-----	-------	---------	--------

<b>ITRC</b> Trick	<b>S</b> Small	<b>BO</b> Base output  <b>HO</b> High output	<b>JB</b> Surface mounted junction box	<b>830</b> 3000K, 80CRI	<b>BL360</b> Blade 360°  <b>LL 1</b> Blade effect	<b>REM</b> Remote	<b>01</b> White  <b>02</b> Black  <b>15</b> Gray  <b>F5</b> Rust brown
----------------------	-------------------	--	--	----------------------------	---	----------------------	--

1 Available with base output (BO).

**ACCESSORY**

(TO BE ORDERED SEPERATELY)

**IMZ53-13** - Adjustable base strip



**REMOTE LED DRIVER OPTIONS (TO BE ORDERED SEPARATELY)**

<b>BLADE EFFECT: ITRC-S-BO-XX-830-LL</b>							5.7W*
Watts	Voltage	Rated	Dimming protocol	Dimming range	Dimensions	Max distance**	Min-max units
<input type="checkbox"/> <b>4444-0350-012-120-LTE</b>							
12	120V	Indoor	Leading and trailing edge (LTE)	Down to 15%	6" X 4" X 3" (152 X 101 X 76mm)	30ft 9m	1-2
<input type="checkbox"/> <b>4548-0350-019-UNV-D10</b>							
19	120/277V	Outdoor	0-10V	Down to 10%	6" X 4.5" X 3" (152 X 114 X 76mm)	30ft 9m	1-3
<input type="checkbox"/> <b>4549-0350-019-UNV-ED10</b>							
19	120/277V	Outdoor	0-10V ELDOLED ECOdrive	Down to ±1%	14.5" X 5" X 3.5" (368 X 127 X 88mm)	118ft 30m	1-3
<input type="checkbox"/> <b>4549-0350-019-UNV-SD10</b>							
19	120/277V	Outdoor	0-10V ELDOLED SOLOdrive	Down to 0.1%	14.5" X 5" X 3.5" (368 X 127 X 88mm)	118ft 30m	1-3

<b>360° BLADE EFFECT: ITRC-S-BO-XX-830-BL360</b>							7.4W*
Watts	Voltage	Rated	Dimming protocol	Dimming range	Dimensions	Max distance**	Min-max units
<input type="checkbox"/> <b>4548-0450-018-120-LTE</b>							
18	120V	Outdoor	Leading and trailing edge (LTE)	Down to 15%	6" X 4.5" X 3" (152 X 114 X 76mm)	30ft (9m)	2
<input type="checkbox"/> <b>4548-0450-024-UNV-D10</b>							
24	120-277V	Outdoor	0-10V	Down to 10%	6" X 4.5" X 3" (152 X 114 X 76mm)	30ft (9m)	1-2
<input type="checkbox"/> <b>4549-0450-024-UNV-ED10</b>							
24	120-277V	Outdoor	0-10V ELDOLED ECOdrive	Down to ±1%	14.5" X 5" X 3.5" (368 X 127 X 89mm)	118ft (30m)	1-2
<input type="checkbox"/> <b>4549-0450-024-UNV-SD10</b>							
24	120-277V	Outdoor	0-10V ELDOLED SOLOdrive	Down to 0.1%	14.5" X 5" X 3.5" (368 X 127 X 89mm)	118ft (30m)	1-2

\* Wattage requirement for one (1) fixture (Remote fixture only).  
\*\*Calculated for 16AWG cable. Contact factory for longer remote distance.

**WIRING DIAGRAMS**

Multiple luminaires must be connected in series (home run or fixture chain).

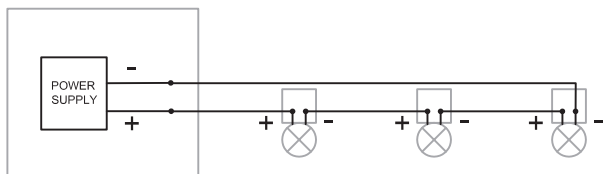

**REMOTE LED DRIVER OPTIONS (TO BE ORDERED SEPARATELY)**

360° BLADE EFFECT: ITRC-S-HO-XX-830-BL360							9.1W*
Watts	Voltage	Rated	Dimming protocol	Dimming range	Dimensions	Max distance**	Min-max units
<input type="checkbox"/> <b>4548-0550-025-120-LTE</b>							
25	120V	Outdoor	Leading and trailing edge (LTE)	Down to 15%	6" X 4.5" X 3" (152 X 114 X 76mm)	30ft (9m)	2
<input type="checkbox"/> <b>4549-0550-030-UNV-SD10</b>							
30	120-277V	Outdoor	0-10V ELDOLED SOLOdrive	Down to 0.1%	14.5" X 5" X 3.5" (368 X 127 X 89mm)	118ft 30m)	1-2
<input type="checkbox"/> <b>4549-0550-030-UNV-ED10</b>							
30	120-277V	Outdoor	0-10V ELDOLED ECOdrive	Down to ±1%	14.5" X 5" X 3.5" (368 X 127 X 89mm)	118ft 30m)	1-2
<input type="checkbox"/> <b>4548-0550-030-UNV-D10</b>							
30	120-277V	Outdoor	0-10V	Down to 10%	6" X 4.5" X 3" (356 X 127 X 76mm)	30ft (9m)	1-2

\* Wattage requirement for one (1) fixture (Remote fixture only).

\*\*Calculated for 16AWG cable. Contact factory for longer remote distance.

**WIRING DIAGRAMS**

Multiple luminaires must be connected in series (home run or fixture chain).

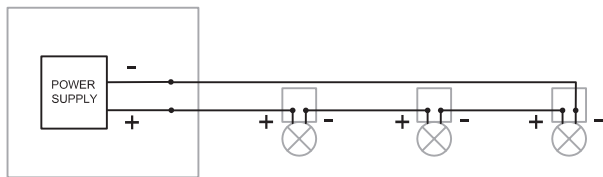

**DIMENSIONS**

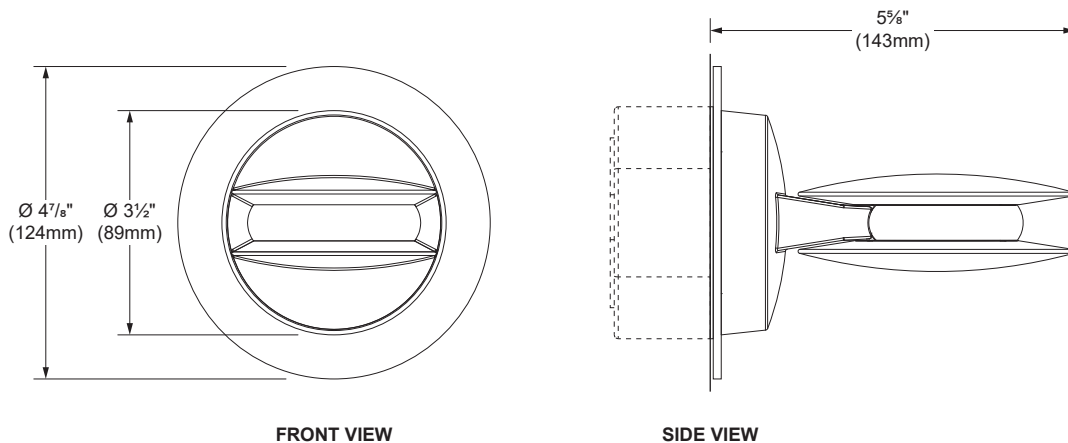

**PHOTOMETRIC DATA**

**BL360 - 360° BLADE EFFECT**



CCT (K)	CRI	OUTPUT	LOAD (W)	OPTIC	LUMENS (lm)	EFFICACY (lm / W)	MAX CANDELA (cd)	MODELS
3000K	80	BO	7.4W	360° blade effect	144	19	467	ITRC-S-BO-XX-830-BL360
		HO	9.1W	360° blade effect	172	18	561	ITRC-S-HO-XX-830-BL360

\* For products that uses a remote led driver, total system wattage will varies according to the efficacy of the remote led driver selected. For this reason, the load and efficacy values given in the table above refers to the led source only and does not include the led driver consumption.

BO 360° blade effect (3000K, 80CRI)

HO 360° blade effect (3000K, 80CRI)

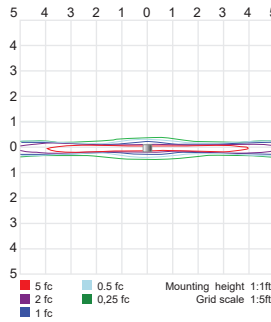
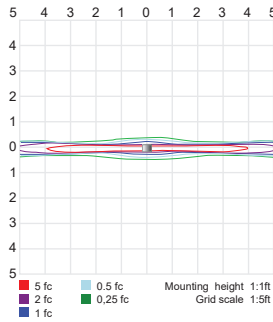
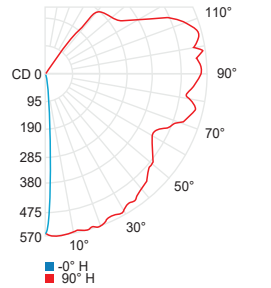
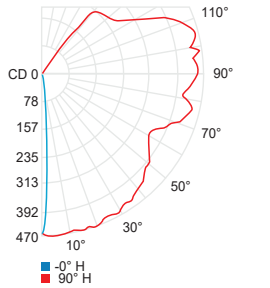

**360° BLADE EFFECT**

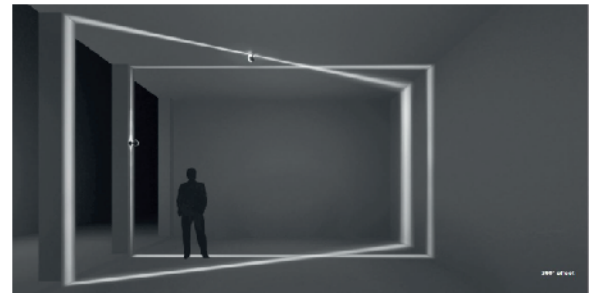

**LL - BLADE EFFECT**



CCT (K)	CRI	OUTPUT	LOAD (W)	OPTIC	LUMENS (lm)	EFFICACY (lm / W)	MAX CANDELA (cd)	MODEL
3000K	80	BO	5.7W	Blade effect	31	5	271	ITRC-S-BO-XX-830-LL

BO blade effect (3000K, 80CRI)

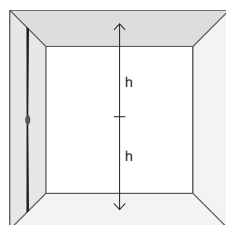
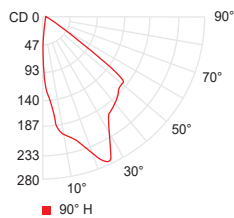

Distance (h)	Blade width	Illuminance
3.2'	3.5"	33.45 fc
6.5'	7"	8.36 fc
9.8'	10.6"	3.72 fc



**LL- LIGHT BLADE EFFECT**

