

Last information update: October 2024

**Product configuration: BQ63**

BQ63: Mini - Wall-/Ceiling-mounted - Warm White LED - 24V/500mA dc - L=262mm - 10° Spot Optic

**Product code**

BQ63: Mini - Wall-/Ceiling-mounted - Warm White LED - 24V/500mA dc - L=262mm - 10° Spot Optic

**Technical description**

Direct light luminaire, designed to use monochrome LED lamps. Ceiling- and wall-mounted. Consists of a body and supports for installation (to be ordered separately). Extruded aluminium body, with zamak die-cast end caps complete with silicone gaskets. Coated with liquid acrylic paint with a high level of weather and UV ray resistance. The top of the optical assembly is closed by a 3 mm thick transparent glass screen, fixed with silicone. Complete with multi-LED power plate in Warm White with 24V/500mA dc electronic circuit (power supply to be ordered separately); 24V/500mA smart driver allowing constant light flow emission despite variations in the input voltage (from 30V dc to 16V dc). Fitted with satin-finish polycarbonate film and optics with plastic (methacrylate) lens for 10° SPOT lighting. All external screws used are made of A2 stainless steel. The luminaire technical characteristics conform to EN 60598-1 standards and particular requirements.

**Installation**

The following accessories are available for installation: adjustable wall-mounted arms in AISI304 stainless steel (L=83mm code BZJ9, 200mm code BZJ8) and a plate for surface- or ceiling-mounting made of anodised aluminium (BZJ6).

**Colour**

Grey (15)

**Weight (Kg)**

0.89

**Mounting**

wall surface|ceiling surface

**Wiring**

The product is supplied with a single nickel-plated brass cable gland PG9 and a 2x1mm<sup>2</sup> PVC and polyurethane outlet cable, 2000mm long. For the electrical connection there is an IP68 linear connector (BZK6) and an IP67 junction box with quick-coupling terminals (BZK7). 24V/500mA dc electronic ballasts to be ordered separately: 32W (BZA0), 25W (K980) and 35W (BZM4)

**Notes**

Product complete with LED lamp

Complies with EN60598-1 and pertinent regulations

**Technical data**

Im system:	213	Colour temperature [K]:	2700
W system:	4.7	MacAdam Step:	3
Im source:	300	Life Time LED 1:	66,000h - L80 - B10 (Ta 25°C)
W source:	4.7	Life Time LED 2:	66,000h - L80 - B10 (Ta 40°C)
Luminous efficiency (Im/W, real value):	45.3	Lamp code:	LED
Im in emergency mode:	-	Number of lamps for optical assembly:	1
Total light flux at or above an angle of 90° [Lm]:	0	ZVEI Code:	LED
Light Output Ratio (L.O.R.) [%]:	71	Number of optical assemblies:	1
Beam angle [°]:	10°	Intervallo temperatura ambiente:	from -30°C to 50°C.
CRI (minimum):	80	LED current [mA]:	500

Polar

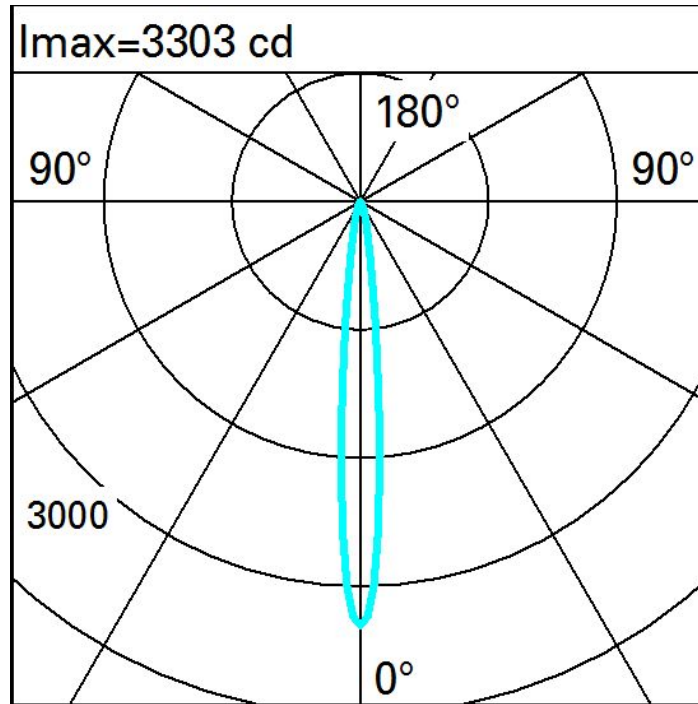

Illuminances

